

SmartGen

MAKING CONTROL SMARTER

HGM9310MPU/9320MPU/9310CAN/9320CAN

GENSET CONTROLLER

USER MANUAL



郑州众智科技股份有限公司
SMARTGEN(ZHENGZHOU)TECHNOLOGY CO.,LTD.

SmartGen 众智 Chinese trademark

SmartGen English trademark

SmartGen – make your generator *smart*

SmartGen Technology Co., Ltd.

No. 28 Jinsuo Road

Zhengzhou

Henan Province

P. R. China

Tel: +86-371-67988888/67981888/67992951

+86-371-67981000(overseas)

Fax: +86-371-67992952

Web: www.smartgen.com.cn/

www.smartgen.cn/

Email: sales@smartgen.cn

All rights reserved. No part of this publication may be reproduced in any material form (including photocopying or storing in any medium by electronic means or other) without the written permission of the copyright holder.

Applications for the copyright holder's written permission to reproduce any part of this publication should be addressed to SmartGen Technology at the address above.

Any reference to trademarked product names used within this publication is owned by their respective companies.



SmartGen Technology reserves the right to change the contents of this document without prior notice.

Table 1 Software Version

Date	Version	Note
2014-07-24	1.0	Original release
2016-11-03	1.1	1. Add timer setting of gas gen-set. 2. Add functions of input ports and output ports.
2017-10-19	1.3	Update user manual format and parameter limit values.
2022-08-20	1.4	Change company logo and manual format.

This manual is suitable for HGM9310MPU, HGM9320MPU, HGM9310CAN and HGM9320CAN series controller only.

Table 2 Sign Instruction

Sign	Instruction
 NOTE	Highlights an essential element of a procedure to ensure correctness.
 CAUTION!	Indicates a procedure or practice, which, if not strictly observed, could result in damage or destruction of equipment.
 WARNING!	Indicates error operation may cause death, serious injury and significant property damage.

SmartGen

CONTENTS

1	OVERVIEW	6
2	MODELS COMPARISON	6
3	PERFORMANCE AND CHARACTERISTICS	7
4	SPECIFICATION	10
5	OPERATION.....	11
5.1	INDICATOR LIGHT.....	11
5.2	KEY FUNCTIONS	12
5.3	LCD DISPLAY.....	13
5.3.1	MAIN DISPLAY.....	13
5.3.2	PARAMETERS SETTING MENU.....	15
5.3.3	DETAILED PARAMETERS SETTING.....	15
5.4	AUTO START/STOP OPERATION.....	18
5.4.1	ILLUSTRATION.....	18
5.4.2	AUTOMATIC START SEQUENCE	18
5.4.3	AUTOMATIC STOP SEQUENCE	18
5.5	MANUAL START/STOP OPERATION	19
5.6	SWITCH CONTROL PROCEDURES.....	19
5.6.1	HGM9320MPU(CAN) SWITCH CONTROL PROCEDURES.....	19
5.6.2	HGM9310MPU(CAN) SWITCH CONTROL PROCEDURES.....	20
6	PROTECTION	22
6.1	WARNINGS.....	22
6.2	SHUTDOWN ALARM	24
6.3	TRIP AND STOP ALARM	26
6.4	TRIP ALARM.....	27
7	WIRINGS CONNECTION	28
8	SCOPES AND DEFINITIONS OF PROGRAMMABLE PARAMETERS.....	31
8.1	CONTENTS AND SCOPES AND PARAMETERS	31
8.2	DEFINED CONTENTS OF OUTPUT PORTS.....	40
8.2.1	DEFINED CONTENTS TABLE OF OUTPUT PORTS	40
8.2.2	CUSTOM PERIOD OUTPUT	45
8.2.3	CUSTOM COMBINED OUTPUT	46
8.3	DEFINED CONTENTS OF DIGITAL INPUT PORTS (ALL GND(B-) ACTIVE).....	47
8.4	SELECTION OF SENSORS.....	49
8.5	CONDITIONS OF CRANK DISCONNECT SELECTION	50
9	PARAMETERS SETTING.....	51
10	SENSORS SETTING	52
11	COMMISSIONING	53
12	TYPICAL APPLICATION	54
13	INSTALLATION	55
14	GSM SHORT MESSAGE ALARM AND REMOTE CONTROL.....	57

14.1	GSM SHORT MESSAGE ALARM	57
14.2	GSM SHORT MESSAGE REMOTE CONTROL.....	57
15	CONNECTIONS OF CONTROLLER WITH J1939 ENGINE.....	59
15.1	CUMMINS ISB/ISBE	59
15.2	CUMMINS QSL9	59
15.3	CUMMINS QSM11 (IMPORT)	60
15.4	CUMMINS QSX15-CM570	60
15.5	CUMMINS GCS-MODBUS	61
15.6	CUMMINS QSM11.....	61
15.7	CUMMINS QSZ13.....	62
15.8	DETROIT DIESEL DDEC III / IV.....	62
15.9	DEUTZ EMR2	63
15.10	JOHN DEERE.....	63
15.11	MTU MDEC.....	64
15.12	MTU ADEC (SMART MODULE).....	64
15.13	MTU ADEC (SAM MODULE)	65
15.14	PERKINS.....	65
15.15	SCANIA.....	66
15.16	VOLVO EDC3.....	66
15.17	VOLVO EDC4.....	67
15.18	VOLVO-EMS2.....	67
15.19	YUCHAI.....	68
15.20	WEICHAI.....	68
16	FAULT FINDING	69

1 OVERVIEW

HGM93XXMPU(CAN) series genset controllers are used for genset automation and monitor control system of single unit to achieve automatic start/stop, data measure, alarm protection and “three remote” (remote control, remote measuring and remote communication). The controller adopts large liquid crystal display (LCD) and selectable Chinese, English or other languages interface with easy and reliable operation.

HGM93XXMPU(CAN) series genset controllers adopt 32-bit micro-processor technology with precision parameters measuring, fixed value adjustment, time setting and threshold adjusting and etc. The majority of parameters can be set using front panel and all the parameters can be set using PC (via USB port) and can be adjusted and monitored with the help of RS485 port. It can be widely used in a number of automatic genset control system with compact structure, simple connections and high reliability.

2 MODELS COMPARISON

Table 3 Models Comparison

Item		HGM9310MPU	HGM9320MPU	HGM9310CAN	HGM9320CAN
LCD	Dimension	4.3"			
	Pixel	480 x 272			
AMF			•		•
Input Port Number		8	8	8	8
Output Port Number		8	8	8	8
Sensor Number		5	5	5	5
Neutral (Earth) Current		•	•	•	•
Schedule Function		•	•	•	•
RS485		•	•	•	•
GSM		•	•	•	•
J1939				•	•
USB		•	•	•	•
Real-time Clock		•	•	•	•
Event Log		•	•	•	•

NOTE:

- (1) Two of the output ports are fixed: start output and fuel output.
- (2) The analog sensors are composed by 3 fixed sensors (temperature, pressure, fuel level) and 2 flexible sensors.

3 PERFORMANCE AND CHARACTERISTICS

HGM9310MPU(CAN), used for single automation systems, auto start/stop of the unit are performed with the help of remote signal.

HGM9320MPU(CAN), has all functions of **HGM9310MPU(CAN)** as well as automatic mains failure function (AMF), particularly well suits for single automation systems that include mains and generator.

Key characteristics,

- With ARM-based 32-bit SCM, highly integrated hardware, new reliability level;
- 480x272 TFT LCD with backlight, multilingual interface (including English, Chinese or other languages) which can be chosen at the site, making commissioning convenient for factory personnel;
- Improved LCD wear-resistance and scratch resistance due to hard screen acrylic;
- Silicon panel and pushbuttons for better operation in high/low temperature environment;
- RS485 communication port enabling remote control, remote measuring, remote communication via ModBus protocol (RS485 communication port is needed);
- Equipped with SMS (Short Message Service) function. When genset is alarming, controller can send short messages via SMS automatically to max. 5 telephone numbers. besides, generator status can be controlled and checked using SMS (GSM port is needed);
- Equipped with CANBUS port and can communicate with J1939 genset. Not only can you monitoring frequently-used data (such as water temperature, oil pressure, speed, fuel consumption and so on) of ECU machine, but also control start, stop, speed raise and speed drop via CANBUS port (CAN BUS port is needed);
- Suitable for 3-phase 4-wire, 3-phase 3-wire, single phase 2-wire, and 2-phase 3-wire systems with voltage 120/240V and frequency 50/60Hz;
- Collects and shows AC 3-phase voltage, current, power parameter and frequency of generator;
- Collects and shows DC voltage, current, and power of generator;

Mains

Line voltage (Uab, Ubc, and Uca)

Phase voltage (Ua, Ub, and Uc)

Phase sequence

Frequency **Hz**

Generator

Line voltage (Uab, Ubc, and Uca)

Phase voltage (Ua, Ub, and Uc)

Phase sequence

Frequency **Hz**

Load

Current **IA, IB, IC**

Each phase and total active power **kW**

Each phase and total reactive power **kvar**

Each phase and total apparent power **kVA**

Each phase and average power factor **PF**

Accumulate total generator power **kWh, kvarh, kVAh**

Earth current **A**

- For generator, controller has over and under voltage, over and under frequency, over current, over power, reverse power, loss of phase and phase sequence wrong functions;
- 3 fixed analog sensors (temperature, oil pressure and fuel level);
- 2 flexible sensors can be set as temperature sensor, oil pressure sensor or level sensor;
- Precision measure and display parameters about Engine,

Temp. (WT)	°C/°F both be displayed
Oil pressure (OP)	kPa/psi/bar all be displayed
Fuel level (FL)	%(unit)
Speed (SPD)	r/min (unit)
Battery Voltage (VB)	V (unit)
Charger Voltage (VD)	V (unit)
- Hour count (HC) can accumulate to max. 65535 hours.
- Start times can accumulate to max. 65535 times.
- Protection: automatic start/stop of the genset, ATS (Auto Transfer Switch) control with perfect failure indication and protection function;
- All output ports are relay-out;
- Parameter setting: parameters can be modified and stored in internal FLASH memory and cannot be lost even in case of power outage; most of them can be adjusted using front panel of the controller and all of them can be modified using PC via USB or RS485 ports.
- More kinds of curves of temperature, oil pressure, fuel level can be used directly and users can define the sensor curves by themselves;
- Multiple crank disconnect conditions (generator frequency, engine speed oil pressure) are optional;
- Widely power supply range DC(8~35)V, suitable to different start battery voltage environment;
- Event log, real-time clock, scheduled start & stop generator (can be set as start genset once a day/week/month whether with load or not);
- PLC (programmable logic control) function allows for specific function can be user-defined.
- Logon wallpaper and display time are user-defined.
- Can be used on pumping units and as an indicating instrument (indicate and alarm are enable only, relay is inhibited);
- With maintenance function. Actions (warning or shutdown) can be set when maintenance time due;
- All parameters used digital adjustment, instead of conventional analog modulation with normal potentiometer, more reliability and stability;
- Waterproof security level IP65 due to rubber seal installed between the controller enclosure and panel fascia;
- Metal fixing clips enable perfect in high temperature environment;

- Modular design, self-extinguishing ABS plastic enclosure, pluggable connection terminals and embedded installation way; compact structure with easy mounting;
- Accumulative total run time and total electric energy of A and B. Users can reset it as 0 and re-accumulative the value which make convenience to users to count the total value as their wish.

SmartGen

4 SPECIFICATION

Table 4 Specification

Item	Content
Operating Voltage	DC8.0V to DC35.0V, Continuous Power Supply.
Power Consumption	<4W (standby ≤2W)
Alternator Input Range	
3-Phase 4-Wire	AC15V - AC 360V (ph-N)
3-Phase 3-Wire	AC30V - AC620V (ph-ph)
Single Phase 2-Wire	AC15V - AC360V (ph-N)
2-Phase 3-Wire	AC15V - AC360V (ph-N)
Alternator Frequency	50Hz/60Hz
Speed Sensor Voltage	1.0V to 24.0V (RMS)
Speed Sensor Frequency	10,000 Hz (max.)
Start Relay Output	16A DC28V supply output
Fuel Relay Output	16A DC28V supply output
Auxiliary Relay Output (1)	7A DC28V supply output
Auxiliary Relay Output (2)	7A DC28V supply output
Auxiliary Relay Output (3)	7A DC28V supply output
Auxiliary Relay Output (4)	7A AC250V voltage free output
Auxiliary Relay Output (5)	7A AC250V voltage free output
Auxiliary Relay Output (6)	7A AC250V voltage free output
Case Dimension	237mm x 172mm x 45mm
Panel Cutout	214mm x160mm
C.T. Secondary	5A rated
Working Temperature	(-25~+70)°C
Working Humidity	(20~93)%RH
Storage Temperature	(-25~+70)°C
Protection Level	IP65 Gasket
Insulating Intensity	Apply AC2.2kV voltage between high voltage terminal and low voltage terminal; The leakage current is not more than 3mA within 1min.
Weight	0.85kg

5 OPERATION

5.1 INDICATOR LIGHT



Fig.1 HGM9310MPU/HGM9310CAN Front Panel

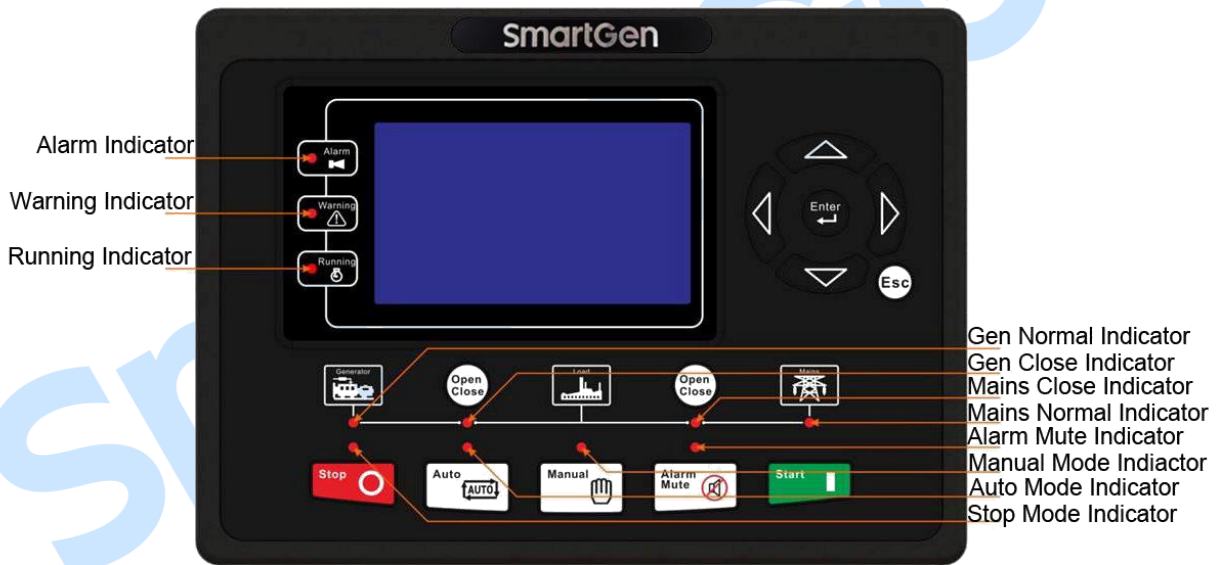

Fig.2 HGM9320MPU/HGM9320CAN Front Panel

Table 5 Warning Indicator and Alarm Indicator

Alarm Type	Warning Indicator	Alarm Indicator
Warning Alarm	Slow flashing	Slow flashing
Trip Alarm	Slow flashing	Slow flashing
Shutdown Alarm	Off	Fast flashing
Trip and Stop Alarm	Off	Fast flashing













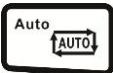

NOTE: Selected light indicators description:



Running indicator: It is illuminated from crank disconnect to ETS while extinguished during other periods.

Generator normal indicator: It is illuminated when generator is normal; flashing when generator state is abnormal; extinguished when there is no generator power.

5.2 KEY FUNCTIONS

Table 6 Key Description





Icons	Keys	Description
	Stop	Stop running generator in Auto/Manual mode; Reset alarms in stop mode; Lamp test (press at least 3 seconds); During stopping process, press this button again to stop generator immediately.
	Start	Start genset in Manual mode.
	Manual Mode	Press this key and controller enters in Manual mode.
	Auto Mode	Press this key and controller enters in Auto mode.
	Mute/Reset Alarm	Alarming sound off; If there is trip alarm, pressing the button at least 3 seconds can reset this alarm.
	Gen Close/Open	Can control generator to switch on or off in manual mode. (HGM9310MPU, HGM9310CAN without)
	Mains Close/Open	Can control mains to switch on or off in manual mode. (HGM9310MPU, HGM9310CAN without).
	Close	Can close breaker in manual mode (HGM9320MPU, HGM9320CAN without).
	Open	Can open breaker in manual mode (HGM9320MPU, HGM9320CAN without).
	Up/Increase	1) Screen scroll; 2) Up cursor and increase value in setting menu.
	Down/Decrease	1) Screen scroll; 2) Down cursor and decrease value in setting menu.
	Left	1) Screen scroll; 2) Left move cursor in setting menu.
	Right	1) Screen scroll; 2) Right move cursor in setting menu.
	Set/Confirm	Entering into parameter setting page after pressing this key for more than 3s; Confirm information in setting page.
	Exit	1. Returns to the main menu; 2. In settings menu returns to the previous menu.

 **NOTE:** In manual mode, pressing  and  simultaneously will force generator to crank. Successful start will not be judged according to crank disconnect conditions, operator will have to crank the starter motor manually; when operator decides that the engine has fired, he/she should release the button and start output will be deactivated, safety on delay will start.

 **WARNING:** Default password is 00318, user can change it in case of others change the advanced parameters setting. Please clearly remember the password after changing. If you forget it, please contact SmartGen services and send all PD information in the controller page of “**ABOUT**” to us.

5.3 LCD DISPLAY

5.3.1 MAIN DISPLAY

Main screen show pages; use   to scroll the pages and   to scroll the screen.

a) **Main screen**, including as below:

- Generator: voltage, frequency, current, active power, reactive power;
- Mains: voltage;
- Engine: speed, temperature, oil pressure, battery voltage;
- Other some status

b) **Status**, including as below,

Status of genset, mains, and switch.

c) **Engine**, including as below,

Speed, engine temperature, engine oil pressure, fuel level, config analog 1, config analog 2, battery voltage, charger voltage, accumulated run time, accumulated start times, user's total run time A, user's total run time B.

 **NOTE:** If connected with J1939 engine via CANBUS port, this page also includes: coolant pressure, coolant level, fuel temperature, inlet head temperature, exhaust head temperature, turbo pressure, fuel consumption, total fuel consumption and so on. (Different engine with different parameters)

d) **Generator**, including as below,

Phase voltage, line voltage, frequency, phase sequence.

e) **Load**, including as below,

Current of each phase, each phase and total active power (positive and negative), each phase and total reactive power (positive and negative), each phase and total apparent power, each phase and average power factor (positive and negative), accumulated energy, earth current, total electric energy A and B.

 **NOTE:** Power factor shows as following,

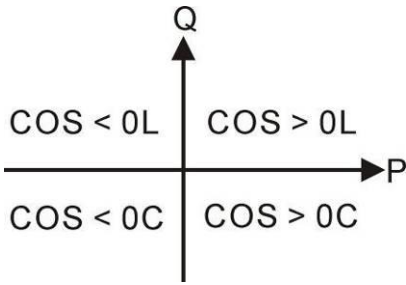

Remark:

P stands for active power

Q stands for reactive power

Table 7 Power Factor

Power Factor	Conditions	Active power	Reactive power	Remark
COS>0L	P>0,Q>0	Input	Input	Load is inductive resistance.
COS>0C	P>0,Q<0	Input	Output	Load is capacitance resistance.
COS<0L	P<0,Q>0	Output	Input	Load equals to one under excitation generator
COS<0C	P<0,Q<0	Output	Output	Load equals to one over excitation generator.

▲NOTE:

Input active power: generator supplies electricity to load;

Output active power: load supplies electricity to generator;

Input reactive power: generator sends reactive power to load;

Output reactive power: load sends reactive power to generator.

f) Mains, including as below,

Phase voltage, line voltage, frequency, phase sequence.

g) Alarm:

Display all alarm information. E.g. warning alarm, shutdown alarm, trip alarm and trip and stop alarm.

▲NOTE: For ECU alarms and shutdown alarms, if the alarm information is displayed, check engine according to it, otherwise, please check the manual of generator according to SPN alarm code.

h) Event log

Records all start/stop events (shutdown alarm, trip and stop alarm, manual /auto start or stop) and the real time and genset status when alarm occurs.

i) Others, including,

Time and Date, and input/output ports status.

j) About, including,

Issue time of software and hardware version, product PD number.

5.3.2 PARAMETERS SETTING MENU

Press and hold  for more than 3 seconds to enter into user menu;

a) Parameter

- After entering the correct password (factory default password is 00318) you can enter parameter settings screen.
- After entering the correct password (09300) you can enter basic parameter settings screen which can meet the demands of most users as the basic parameters can be set in sequence.

b) Language

Selectable Simplified Chinese, English and others (default: Simplified Chinese).

c) Commissioning

On load, off load or custom commissioning can be chosen. Custom commissioning can configure on load or not during commissioning, when to commissioning and select the mode after commissioning (manual mode, auto mode and stop mode).

d) Clear users' accumulation





Can clear total run time A and B, total electric energy A and B.





5.3.3 DETAILED PARAMETERS SETTING





- Mains settings
- Timer settings
- Engine settings
- Generator settings
- Load settings
- Switch settings
- Temperature sensor settings
- Oil pressure sensor settings
- Level sensor settings
- Flexible sensor 1
- Flexible sensor 2
- Input port settings
- Output port settings
- Module settings
- Scheduling and maintenance settings
- GSM settings
- Exp. input settings



- Exp. output setting
- Exp. AIN24 1 settings
- Exp. AIN24 2 settings







Example,





Return	>Start Delay	Screen1: Use   to scroll settings,  to enter settings (Screen 2),  to exit settings menu.
Mains	>Return Delay	
Timers >	>Preheat Delay	
Engine	>Cranking Time	
Generator	>Crank Rest Time	
Load	>Safety On Time	
Switch	>Start Idle Time	
Temp. Sensor	>Warming Up Time	
OP Sensor	>Cooling Time	
Level Sensor	>Stop Idle Time	
Flexible Sensor 1	>ETS Hold Time	



Return	> Start Delay	Screen 2: Use   to scroll settings,  to enter settings (Screen 4),  to return to previous menu. (Screen 1).
Mains	> Return Delay	
Timers >	> Preheat Delay	
Engine	> Cranking Time	
Generator	> Crank Rest Time	
Load	> Safety On Time	
Switch	> Start Idle Time	
Temp. Sensor	> Warming Up Time	
OP Sensor	> Cooling Time	
Level Sensor	> Stop Idle Time	
Flexible Sensor 1	> ETS Hold Time	

Return	>Start Delay	Screen 3: Use   to scroll settings,  to enter settings (Screen 4),  to return to previous menu. (Screen 1).
Mains	> Return Delay	
Timers >	> Preheat Delay	
Engine	> Cranking Time	
Generator	> Crank Rest Time	
Load	> Safety On Time	
Switch	> Start Idle Time	
Temp. Sensor	> Warming Up Time	
OP Sensor	> Cooling Time	
Level Sensor	> Stop Idle Time	
Flexible Sensor 1	> ETS Hold Time	

> Start Delay	00008s	Screen 4: Press  to enter settings (Screen 5),  to return to previous menu. (Screen 6).
> Return Delay		
> Preheat Delay		
> Cranking Time		
>Crank Rest Time		
> Safety On Time		
> Start Idle Time		
> Warming Up Time		
> Cooling Time		
> Stop Idle Time		
> ETS Hold Time		

> Start Delay	00008s	Screen 5: Press   to change cursor position,   are used for changing cursor value,  Confirm setting (Interface 4),  exit setting (Screen 4).
> Return Delay		
>Preheat Delay		
> Cranking Time		
> Crank Rest Time		
> Safety On Time		
> Start Idle Time		
> Warming Up Time		
> Cooling Time		
> Stop Idle Time		
> ETS Hold Time		

> Start Delay	00008s	Screen 6: Use   to scroll settings.  to enter settings (Screen 4),  to return to previous menu. (Screen 1).
> Return Delay		
> Preheat Delay		
> Cranking Time		
> Crank Rest Time		
> Safety On Time		
> Start Idle Time		
> Warming Up Time		
> Cooling Time		
> Stop Idle Time		
> ETS Hold Time		

 **NOTE:** Pressing  can exit setting directly during setting.

5.4 AUTO START/STOP OPERATION

5.4.1 ILLUSTRATION

Auto mode is selected by pressing the  button; a LED beside it will illuminate to confirm the operation.

5.4.2 AUTOMATIC START SEQUENCE

- a) HGM9320MPU(CAN): When Mains is abnormal (over and under voltage, over and under frequency, loss of phase, phase sequence wrong), it enters into mains “Abnormal Delay” and LCD display count down time. When mains abnormal delay is over, it enters into “Start Delay”; it also enters into this mode when “Remote Start On Load” is active.
- b) HGM9310MPU(CAN): When “Remote Start (on load)” is active, “Start Delay” timer is initiated;
- c) “Start Delay” countdown will be displayed on LCD;
- d) When start delay is over, preheat relay energizes (if configured), “Preheat Delay XX s” information will be displayed on the downmost line of LCD;
- e) After the above delay, the Fuel Relay (if configured) is energized, and then one second later, the Start Relay is engaged. The engine is cranked for a pre-set time. If the engine fails to fire during this cranking attempt then the fuel relay and start relay are disengaged for the pre-set rest period; “Crank Rest Time” begins and wait for the next crank attempt.
- f) Should this start sequence continue beyond the set number of attempts, the start sequence will be terminated, the first line of LCD display will be highlighted with black and “Fail to Start” fault will be displayed.
- g) In case of successful crank attempt, the “Safety On” timer is activated, allowing Low Oil Pressure, High Temperature, under speed and Charge Alternator Failure inputs to stabilize without triggering the fault. As soon as this delay is over, “Start Idle” delay is initiated (if configured).
- h) During “Start Idle” delay, under speed, under frequency, under voltage alarms are inhibited. When this delay is over, “Warming Up” delay is initiated (if configured).
- i) After the “Warming Up” delay has expired, if generator status is normal, its indicator will be illuminated. If generator voltage and frequency have reached on-load requirements, then the generator close relay will be energized; genset will take load; generator power indicator will illuminate and generator will enter into Normal Running status. If voltage or frequency is abnormal, the controller will initiate shutdown alarm (alarm information will be displayed on LCD).

 **NOTE:** When started via “Remote Start (off Load)” input, same procedures as above but generator close relay deactivated, moreover, genset off load.



5.4.3 AUTOMATIC STOP SEQUENCE

- a) HGM9320MPU(CAN), when mains return normal during genset running, enters into mains voltage

“Normal Delay” and its indicator illuminated. When mains normal delay is over, enter into “stop delay”; also can be into this mode when “Remote Start On Load” is inactive.

- b) HGM9310MPU(CAN): When the “Remote Start” signal is removed, “Stop Delay” is initiated.
- c) Once this “Stop Delay” has expired, the Generator Breaker will open and the “Cooling Delay” is then initiated. After “Transfer Delay”, close mains relay is energized and mains will take load. Generator indicator extinguish while mains indicator lights.
- d) During “Stop Idle” Delay (if configured), idle relay is energized.
- e) “ETS Solenoid Hold” delay begins, ETS relay is energized while fuel relay is de-energized, complete stop is detected automatically.
- f) “Wait for Stop Delay” begins, complete stop is detected automatically.
- g) When generator is stop completely, “After Stop” delay will be initiated. Otherwise, fail to stop alarm is initiated and the corresponding alarm information is displayed on LCD. (If generator is stop successfully after “fail to stop” alarm has initiated, “After Stop” delay will be initiated and the alarm will be removed)
- h) Generator is placed into its standby mode after its “After Stop” delay.

5.5 MANUAL START/STOP OPERATION

- a) **MANUAL START:** Manual mode is selected by pressing the  button; a LED besides the button will illuminate to confirm the operation; then press  button to start the gen-set; can detect crank disconnect condition and generator accelerates to high-speed running automatically. With high temperature, low oil pressure, over speed and abnormal voltage during generator running, controller can protect genset to stop quickly. (please refer to 5.4.2, d)~5.4.2, i)).
- b) **MANUAL STOP:** Press  can stop the running generators. (please refer to 5.4.3, c)~5.4.3, h)).

5.6 SWITCH CONTROL PROCEDURES



5.6.1 HGM9320MPU(CAN) SWITCH CONTROL PROCEDURES

Manual transfer procedures:

When controller is in **Manual** mode, the switch control procedures will start through manual transfer process.



Users can control the loading transfer of ATS via pressing button to switch on or off.

A. If “Open breaker detect” is “SELECT Disable”

- Press generator switch on or off key , if generator has taken load, will send unload signal; if taken no load, generator will send load signal; if mains has taken load, will send unload signal, and then generator will take load after the mains “open delay”.
- Press mains switch on or off key , if mains has taken load, will send unload signal; if taken no

load, mains will send load signal; if generator has taken load, will send unload signal, and then mains will take load after the generator “open delay”.

If “Open breaker detect” is “SELECT Enable”

- To transfer load from mains to generator need to press mains switch off key  firstly. After open delay, press generator switch on key , and generator will take load (there is no action when pressing switch on key directly).
- The way to transfer from generator to mains is as same as above.

Auto transfer procedures:

When controller is in **AUTO** mode, switch control procedures will start through automatic transfer.

1) If input port is configured as Close Mains Auxiliary

A. If “Open breaker detect” is “SELECT Enable”

- When transferring load from mains to generator, controller begins detecting “fail to transfer”, then the open delay and transfer rest delay will begin. When detecting time out, if switch open failed, the generator will not switch on, otherwise, generator switch on. Detecting transfer failure while generator switches on. When detecting time out, if switch on fail, it is need to wait for generator to switch on. If transfer failed and warning “SELECT Enable”, there is alarming signal whatever switch on or off failure.
- The way to transfer from generator load to mains load is as same as above.

B. If “Open breaker detect” is “SELECT Disable”

- Mains load is transferred into generator load, after the delay of switch off and transfer interval, generator switch on. Detecting transfer fail while generator switches on. After detecting time out, if switch on fail, then wait for generator switch on. If transfer fail and warning “SELECT Enable”, there is alarming signal.

2) If input port is not configured as Close Mains Auxiliary

Mains load is transferred into generator load, after switch off and transfer interval delay, generator switch on.

The way to transfer generator load to mains load is as same as above.

5.6.2 HGM9310MPU(CAN) SWITCH CONTROL PROCEDURES

Manual control procedures,

When controller is in Manual mode, manual control will be executive.

Users can control switch on or off by pressing panel key. Press generator switch on key , generator will

output load signal. Press generator switch off key  , generator will output unload signal.

Auto control procedures,

When controller is in auto mode, switch control procedures will start auto transfer.

1) If input port is configured as Close Mains Auxiliary

A. If "Open breaker detect" is select "Enable"

Generator load is transferred into generator unload, after the open delay, the controller detects "transfer failure" while open signal is outputting. When detecting time out, if open failed, it will wait for breaker opened. Otherwise, breaker open is completed.

Generator unload is transferred into generator load, after the close delay, the controller detects "transfer failure" while close signal is outputting. When detecting time out, if close failed, it will wait for breaker closed. Otherwise, breaker close is completed.

If transfer failed and warning select "Enable", there is alarming signal whatever breaker open or close failure.

B. If "Open breaker detect" is select "Disable"

Generator unload is transferred into generator load, after the close delay, the controller detects "transfer failure" while close signal is outputting. When detecting time out, if close failed, it will wait for breaker closed. Otherwise, breaker close is completed.

If transfer failed and warning select "Enable", there is alarming signal whatever breaker open or close failure.

2) If input port is not configured as Close Mains Auxiliary

Generator un-load is transferred into generator load, close generator output.

Generator load is transferred into generator un-load, open generator output.

NOTE:

When using ATS of no interposition, "Open breaker detect" should "Disable";

When using ATS of having interposition, "Open breaker detect" select "Disable" or "Enable" both are OK. If select "Enable", breaker open output should be configured;

When using AC contactor, "Open breaker detect" should select "Enable".

6 PROTECTION

6.1 WARNINGS

When controller detects warning signals, it only sends warning without shutdown.

Table 8 Warning Alarms

No	Type	Description
1	Over Speed	When the controller detects that the engine speed has exceeded the pre-set value, it will initiate a warning alarm.
2	Under Speed	When the controller detects that the engine speed has fallen below the pre-set value, it will initiate a warning alarm.
3	Loss of Speed	When the controller detects that the engine speed is 0 and the action select "Warning", it will initiate a warning alarm.
4	Over Frequency	When the controller detects that the genset frequency has exceeded the pre-set value, it will initiate a warning alarm.
5	Under Frequency	When the controller detects that the genset frequency has fallen below the pre-set value, it will initiate a warning alarm.
6	Over Voltage	When the controller detects that the generator voltage has exceeded the pre-set value, the controller will initiate a warning alarm.
7	Under Voltage	When the controller detects that the genset voltage has fallen below the pre-set value, it will initiate a warning alarm.
8	Over Current	When the controller detects that the genset current has exceeded the pre-set value and the action select "Warning", it will initiate a warning alarm.
9	Fail To Stop	After "fail to stop" delay, if gen-set does not stop completely, it will initiate a warning alarm.
10	Charge Alternator Failure	When the controller detects that charger voltage has fallen below the pre-set value, it will initiate a warning alarm.
11	Battery High Voltage	When the controller detects that start battery voltage has exceeded the pre-set value, it will initiate a warning alarm.
12	Battery Low Voltage	When the controller detects that start battery voltage has fallen below the pre-set value, it will initiate a warning alarm.
13	Maintenance Due	When count down time is 0 and the action select "Warning", it will initiate a warning alarm.
14	Reverse Power	If reverse power detection is enabled, when the controller detects that the reverse power value (power is negative) has fallen below the pre-set value and the action select "Warning", it will initiate a warning alarm.
15	Over Power	If over power detection is enabled, when the controller detects that the over power value (power is positive) has exceeded the pre-set value and the action select "Warning", it will initiate a warning alarm.
16	ECU Warn	If an error message is received from ECU via J1939, it will initiate a warning alarm.

No	Type	Description
17	Gen Loss of Phase	If loss of phase detection is enabled, When controller detects the generator loss phase, it will initiate a warning alarm.
18	Gen Phase Sequence Wrong	When the controller detects a phase rotation error, it will initiate a warning alarm.
19	Switch Fail Warn	When the controller detects that the breaker close or open failure occurs, and the action select "Warning", it will initiate a warning alarm.
20	Temperature Sensor Open Circuit	When the controller detects that the temperature sensor is open circuit and the action select "Warning", it will initiate a warning alarm.
21	High Temperature Warn	When the controller detects that engine temperature has exceeded the pre-set value, it will initiate a warning alarm.
22	Low Temperature Warn	When the controller detects that engine temperature has fallen below the pre-set value, it will initiate a warning alarm.
23	Oil Pressure Open Circuit	When the controller detects that the oil pressure sensor is open circuit and the action select "Warning", it will initiate a warning alarm.
24	Low Oil Pressure Warn	When the controller detects that the oil pressure has fallen below the pre-set value, it will initiate a warning alarm.
25	Level Sensor Open Circuit	When the controller detects that the level sensor is open circuit and the action select "Warning", it will initiate a warning alarm.
26	Low Fuel Level Warn	When the controller detects that the fuel level has fallen below the pre-set value, it will initiate a warning alarm.
27	Flexible Sensor 1 Open Circuit	When the controller detects that the flexible sensor 1 is open circuit and the action select "Warning", it will initiate a warning alarm.
28	Flexible Sensor 1 High	When the controller detects that the sensor 1 value has exceeded the pre-set value, it will initiate a warning alarm.
29	Flexible Sensor 1 Low	When the controller detects that the sensor 1 value has fallen below the pre-set value, it will initiate a warning alarm.
30	Flexible Sensor 2 Open Circuit	When the controller detects that the flexible sensor 2 is open circuit and the action select "Warning", it will initiate a warning alarm.
31	Flexible Sensor 2 High	When the controller detects that the sensor 2 value has exceeded the pre-set value, it will initiate a warning alarm.
32	Flexible Sensor 2 Low	When the controller detects that the sensor 2 value has fallen below the pre-set value, it will initiate a warning alarm.
33	Digital Input	When digit input port is set as warning and the alarm is active, it will initiate a warning alarm.
34	GSM Com Fail	When select GSM enable but the controller couldn't detect GSM model, controller sends corresponding warning signal.
35	Earth Fault	If earth fault detection is enabled, when the controller detects that the earth fault current has exceeded the pre-set value and the action select "Warn", it will initiate a warning alarm.

6.2 SHUTDOWN ALARM

When controller detects shutdown alarm, it will send signal to open breaker and shut down generator.

Table 9 Shutdown Alarms

No	Type	Description
1	Emergency Stop	When the controller detects an emergency stop alarm signal, it will initiate a shutdown alarm.
2	Over Speed	When the controller detects that the generator speed has exceeded the pre-set value, it will initiate a shutdown alarm.
3	Under Speed	When the controller detects that the generator speed has fallen below the pre-set value, it will initiate a shutdown alarm.
4	Loss of Speed Signal	When the controller detects that the engine speed is 0 and the action select "Shutdown", it will initiate a shutdown alarm.
5	Over Frequency	When the controller detects that the genset frequency has exceeded the pre-set value, it will initiate a shutdown alarm.
6	Under Frequency	When the controller detects that the genset frequency has fallen below the pre-set value, it will initiate a shutdown alarm.
7	Over Voltage	When the controller detects that the generator voltage has exceeded the pre-set value, the controller will initiate a shutdown alarm.
8	Under Voltage	When the controller detects that the genset voltage has fallen below the pre-set value, it will initiate a shutdown alarm.
9	Fail To Start	If the engine does not fire after the pre-set number of attempts, it will initiate a shutdown alarm.
10	Over Current	When the controller detects that the genset current has exceeded the pre-set value and the action select "Shutdown", it will initiate a shutdown alarm.
11	Maintenance 1 Due	When count down time is 0 and the action select "Shutdown", it will initiate a shutdown alarm.
12	ECU Shutdown	If an error message is received from ECU via J1939, it will initiate a shutdown alarm.
13	ECU Fail	If the module does not detect the ECU data, it will initiate a shutdown alarm.
14	Reverse Power Shutdown	If reverse power detection is enabled, when the controller detects that the reverse power value (power is negative) has fallen below the pre-set value and the action select "Shutdown", it will initiate a shutdown alarm.
15	Over Power Shutdown	If over power detection is enabled, when the controller detects that the over power value (power is positive) has exceeded the pre-set value and the action select "Shutdown", it will initiate a shutdown alarm.
16	Temperature Sensor Open Circuit	When the controller detects that the temperature sensor is open circuit and the action select "Shutdown", it will initiate a shutdown alarm.

No	Type	Description
17	High Temperature Shutdown	When the controller detects that engine temperature has exceeded the pre-set value, it will initiate a shutdown alarm.
18	Oil Pressure Open Circuit	When the controller detects that the oil pressure sensor is open circuit and the action select "Shutdown", it will initiate a shutdown alarm.
19	Low Oil Pressure Shutdown	When the controller detects that the oil pressure has fallen below the pre-set value, it will initiate a shutdown alarm.
20	Level Sensor Open Circuit	When the controller detects that the level sensor is open circuit and the action select "Shutdown", it will initiate a shutdown alarm.
21	Flexible Sensor 1 Open Circuit	When the controller detects that the flexible sensor 1 is open circuit and the action select "Shutdown", it will initiate a shutdown alarm.
22	Flexible Sensor 1 High	When the controller detects that the sensor 1 value has exceeded the pre-set value, it will initiate a shutdown alarm.
23	Flexible Sensor 1 Low	When the controller detects that the sensor 1 value has fallen below the pre-set value, it will initiate a shutdown alarm.
24	Flexible Sensor 2 Open Circuit	When the controller detects that the flexible sensor 2 is open circuit and the action select "Shutdown", it will initiate a shutdown alarm.
25	Flexible Sensor 2 High	When the controller detects that the sensor 2 value has exceeded the pre-set value, it will initiate a shutdown alarm.
26	Flexible Sensor 2 Low	When the controller detects that the sensor 2 value has fallen below the pre-set value, it will initiate a shutdown alarm.
27	Digital Input	When digit input port is set as shutdown and the alarm is active, it will initiate a shutdown alarm.
28	Earth Fault	If earth fault detection is enabled, when the controller detects that the earth fault current has exceeded the pre-set value and the action select "Shutdown", it will initiate a shutdown alarm.
29	Low Coolant Level	Controller initiate shutdown alarm after digital input port been configured as low coolant level shutdown (is active).
30	Detonation Shutdown	Controller initiate shutdown alarm after digital input port been configured as detonation shutdown (is active).
31	Gas Leak Shutdown	Controller initiate shutdown alarm after digital input port been configured as gas leak shutdown (is active).

6.3 TRIP AND STOP ALARM

When controller detects trip and stop alarm, it will disconnect “Close Generator” Output and shut down the genset.

Table 10 Trip and Stop Alarms

No	Type	Description
1	Over Current	When the controller detects that the genset current has exceeded the pre-set value and the action select “Trip and Stop”, it will initiate a trip and stop alarm.
2	Reverse Power	If reverse power detection is enabled, when the controller detects that the reverse power value (power is negative) has fallen below the pre-set value and the action select “Trip and Stop”, it will initiate a trip and stop alarm.
3	Over Power	If over power detection is enabled, when the controller detects that the over power value (power is positive) has exceeded the pre-set value and the action select “Trip and Stop”, it will initiate a trip and stop alarm.
4	Digital Input	When digit input port is set as “Trip and Stop” and the alarm is active, it will initiate a trip and stop alarm.
5	Earth Fault	If earth fault detection is enabled, when the controller detects that the earth fault current has exceeded the pre-set value and the action select “Trip and Stop”, it will initiate a trip and stop alarm.

6.4 TRIP ALARM

When controller detects stop alarm, it will disconnect “Close Generator” Output and not shut down the genset.

Table 11 Trip Alarms

No	Type	Description
1	Over Current	When the controller detects that the genset current has exceeded the pre-set value and the action select “Trip”, it will initiate a trip alarm.
2	Reverse Power	If reverse power detection is enabled, when the controller detects that the reverse power value (power is negative) has fallen below the pre-set value and the action select “Trip”, it will initiate a trip alarm.
3	Over Power	If over power detection is enabled, when the controller detects that the over power value (power is positive) has exceeded the pre-set value and the action select “Trip”, it will initiate a trip alarm.
4	Digital Input	When digit input port is set as “Trip” and the alarm is active, it will initiate a trip alarm.
5	Earth Fault	If earth fault detection is enabled, when the controller detects that the earth fault current has exceeded the pre-set value and the action select “Trip”, it will initiate a trip alarm.

7 WIRINGS CONNECTION

HGM93XXMPU(CAN) series controller's rear as following:

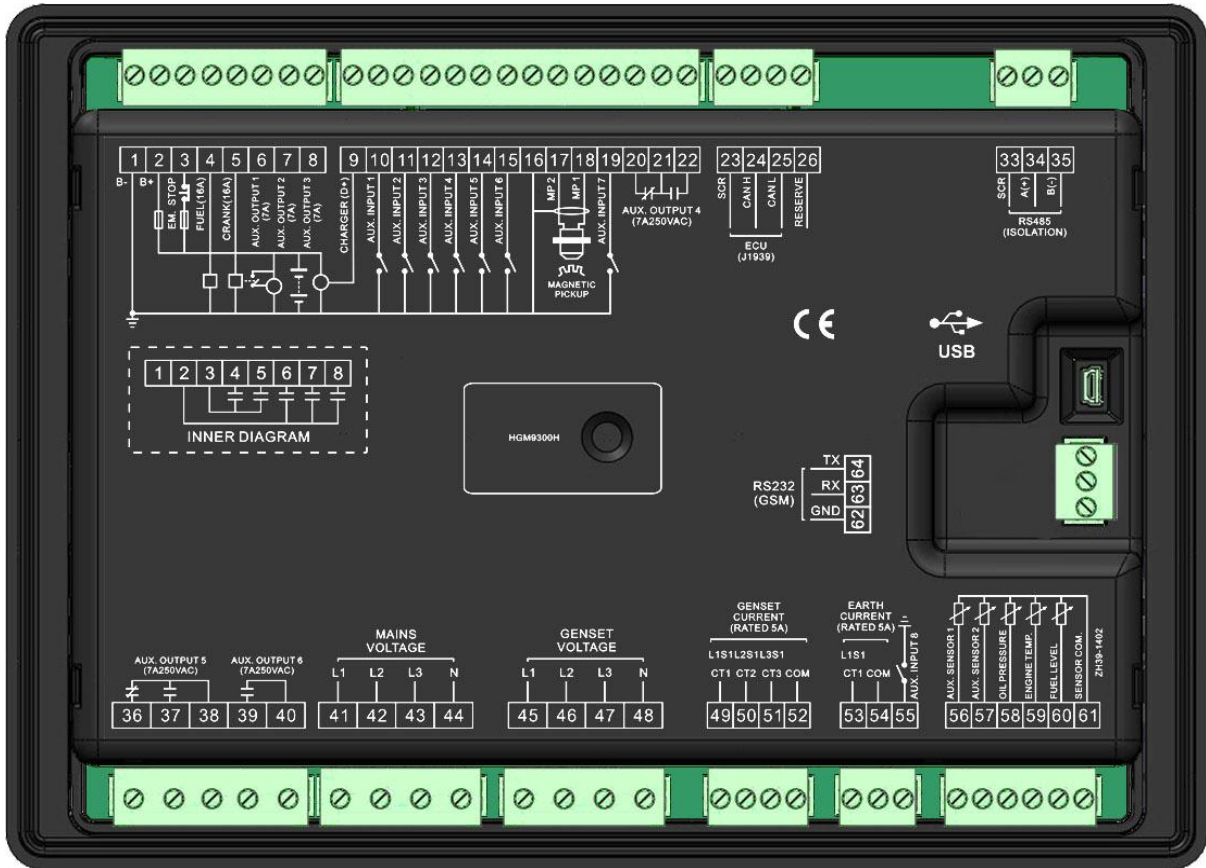

Fig.3 Rear Panel

Table 12 Description of Terminal Connection

No.	Function	Size	Remarks	
1	B-	2.5mm ²	Connected with negative of starter battery.	
2	B+	2.5mm ²	Connected with positive of starter battery. If wire length is over 30m, better to double wires in parallel. Max. 20A fuse is recommended.	
3	Emergency stop	2.5mm ²	Connected with B+ via emergency stop button.	
4	Fuel relay output	1.5mm ²	B+ is supplied by No.3 terminal, rated 16A.	
5	Crank relay output	1.5mm ²	B+ is supplied by No.3 terminal, rated 16A.	Connected to starter coil.
6	Aux. Output 1	1.5mm ²	B+ is supplied by No.2 terminal, rated 7A.	Details see table 13.
7	Aux. Output 2	1.5mm ²	B+ is supplied by No.2 terminal, rated 7A.	
8	Aux. Output 3	1.5mm ²	B+ is supplied by No.2 terminal, rated 7A.	
9	Charger (D+)	1.0mm ²	Connected with charger starter's D+ (WL) terminals. Being hang up If there is no this terminal.	
10	Aux. Input 1	1.0mm ²	Ground connected is active (B-).	Details see table 14

No.	Function	Size	Remarks	
11	Aux. Input 2	1.0mm ²	Ground connected is active (B-).	
12	Aux. Input 3	1.0mm ²	Ground connected is active (B-).	
13	Aux. Input 4	1.0mm ²	Ground connected is active (B-).	
14	Aux. Input 5	1.0mm ²	Ground connected is active (B-).	
15	Aux. Input 6	1.0mm ²	Ground connected is active (B-).	
16	Magnetic Pickup	0.5mm ²	Connected with Speed sensor, shielding line is recommended. (B-) has already connected with speed sensor 2.	
17	Magnetic Pickup 2			
18	Magnetic Pickup 1			
19	Aux. Input 7	1.0mm ²	Ground connected is active (B-).	Details see table 14.
20	Aux. Output 4	1.5mm ²	Normally close output, rated 7A.	Details see table 13.
21			Public points of relay.	
22			Normally open output, rated 7A.	
23	ECU SCR	/	Impedance-120Ω shielding wire is recommended, its single-end earthed.	
24	ECU CAN H	0.5mm ²		
25	ECU CAN L	0.5mm ²		
26	RESERVE	/	Empty terminal	
33	RS485 SCR	/	Impedance-120Ω shielding wire is recommended, its single-end earthed.	
34	RS485A(+)	0.5mm ²		
35	RS485B(-)	0.5mm ²		
36	Aux. Output 5	2.5mm ²	Normally close output, rated 7A.	Details see table 13.
37		2.5mm ²	Normally open output, rated 7A.	
38		2.5mm ²	Public points of relay.	
39		2.5mm ²	Normally open output, rated 7A.	
40	Aux. Output 6	2.5mm ²	Public points of relay.	
41	Mains L1-phase voltage input	1.0mm ²	Connected to A-phase of mains (2A fuse is recommended). (HGM9310MPU, HGM9310CAN without).	
42	Mains L2-phase voltage input	1.0mm ²	Connected to B-phase of mains (2A fuse is recommended). (HGM9310MPU, HGM9310CAN without).	
43	Mains L3-phase voltage input	1.0mm ²	Connected to C-phase of mains (2A fuse is recommended). (HGM9310MPU, HGM9310CAN without).	
44	Mains N-wire input	1.0mm ²	Connected to N-wire of mains. (HGM9310MPU, HGM9310CAN without).	
45	Genset L1-phase voltage input	1.0mm ²	Connected to A-phase of genset (2A fuse is recommended).	
46	Genset L2-phase voltage input	1.0mm ²	Connected to B-phase of genset (2A fuse is recommended).	
47	Genset L3-phase voltage input	1.0mm ²	Connected to C-phase of genset (2A fuse is recommended).	
48	Genset N-wire input	1.0mm ²	Connected to N-wire of gen-set.	

No.	Function	Size	Remarks	
49	CT 1 input	1.5mm ²	Outside connected to secondary coil of current transformer (rated 5A).	
50	CT 2 input	1.5mm ²	Outside connected to secondary coil of current transformer (rated 5A).	
51	CT 3 input	1.5mm ²	Outside connected to secondary coil of current transformer (rated 5A).	
52	CT COM	1.5mm ²	See following installation instruction.	
53	Earth Current	1.5mm ²	Outside connected to secondary coil of current transformer (rated 5A).	
54		1.5mm ²		
55	Aux. Input 8	1.0mm ²	Ground connected is active (B-).	Details see table 14.
56	Aux. sensor 1	1.0mm ²	Connected to temperature, oil pressure or level sensors.	Details see table 15.
57	Aux. sensor 2	1.0mm ²		
58	Oil pressure sensor	1.0mm ²	Connected to oil pressure sensor.	
59	Temperature sensor	1.0mm ²	Connected to temperature sensor.	
60	Fuel level sensor	1.0mm ²	Connected to fuel level sensor.	
61	Sensor COM	/	Public terminal of sensor, (B-) has already connected.	
62	RS232 GND	0.5mm ²	Connected to GSM module.	
63	RS232 RX	0.5mm ²		
64	RS232 TX	0.5mm ²		

NOTE: USB ports in controller rear panel are programmable parameter ports, user can directly configure controller via PC.

NOTE: Please refer to the Module Comparison in this manual for more details.

8 SCOPES AND DEFINITIONS OF PROGRAMMABLE PARAMETERS

8.1 CONTENTS AND SCOPES OF PARAMETERS

Table 13 Parameters Description

No.	Items	Parameters	Defaults	Description
Mains				
1	AC System	(0~3)	0	0: 3P4W; 1: 3P3W; 2: 2P3W; 3: 1P2W.
2	Rated Voltage	(30~30000)V	230	Standard for checking mains over/under voltage. (It is primary voltage when using voltage transformer).
3	Rated Frequency	(10.0~75.0)Hz	50.0	Standard for checking mains over/under frequency.
4	Normal Delay	(0~3600)s	10	The delay from mains abnormal to normal.
5	Abnormal Delay	(0~3600)s	5	The delay from mains normal to abnormal.
6	Volt. Trans.(PT)	(0~1)	0	0: Disable; 1: Enable
		(30-30000)V	100	PT primary.
		(30-1000)V	100	PT secondary.
7	Over Voltage	(0~200)%	120	Setting value is mains rated voltage's percentage, and return value (Over Voltage default: 116; Under Voltage default: 84) and delay value (default: 5s) can be set.
8	Under Voltage	(0~200)%	80	
9	Over Frequency	(0~200)%	114	Setting value is mains rated frequency's percentage, return value (Over Frequency default: 110; Under Frequency default: 94) and delay value (default: 5s) can be set.
10	Under Frequency	(0~200)%	90	
11	Loss of Phase	(0~1)	1	0: Disable; 1: Enable
12	Phase Sequence Wrong	(0~1)	1	
Timers				
1	Start Delay	(0~3600)s	1	Time from mains abnormal or remote start signal is active to start genset.
2	Stop Delay	(0~3600)s	1	Time from mains normal or remote start signal is deactivated to stop genset.
3	Pre-heat Delay	(0~3600)s	0	Time of pre-powering heat plug before starter is powered up.
4	Cranking Time	(3~60)s	8	Time of starter power up.
5	Crank Rest Time	(3~60)s	10	The waiting time before second power up when engine start fail.
6	Safety On Delay	(0~3600)s	10	Alarms for low oil pressure, high

No.	Items	Parameters	Defaults	Description
				temperature, under speed, under frequency /voltage, charge fail are inactive.
7	Start Idle Time	(0~3600)s	0	Idle running time of genset when starting.
8	Warming Up Time	(0~3600)s	10	Warming time between genset switch on and normal running.
9	Cooling Time	(0~3600)s	10	Radiating time before genset stop, after it unloads.
10	Stop Idle Time	(0~3600)s	0	Idle running time when genset stop.
11	ETS Solenoid Hold	(0~3600)s	20	The time of powering up the electromagnet during stop procedure.
12	Fail to Stop Delay	(0~3600)s	0	Time between ending of genset idle delay and stopped when "ETS time" is set as 0; Time between ending of ETS hold delay and stopped when "ETS Hold output time" is not 0.
13	After Stop Time	(0~3600)s	0	Time between genset stopped and standby
14	Gas Engine Timers	(0-1)	0	0: Enable 1: Disable When gas engine timer enabled, fuel oil output is used for controlling gas valve.
15	Choke On Time	(0-60)s	0	Gas enrichment control output time when start engine.
16	Gas On Delay	(0-60)s	0	When engine started, it starts to output after the preset time delay.
17	Ignition Off Delay	(0-60)s	0	When gas valve closed, it stops to output after the preset delay.
Engine				
1	Engine Type	(0~39)	0	Default: Conventional genset (not J1939) When connected to J1939 engine, choose the corresponding type.
2	Flywheel Teeth	(10~300)	118	Tooth number of the engine, which used for judging of crank disconnect conditions and inspecting of engine speed. See the installation instructions.
3	Rated Speed	(0~6000)r/min	1500	Offer standard to judge over/under/loading speed.
4	Loading Speed	(0~100)%	90	Setting value is percentage of rated speed. Controller detects when it is ready to load. It won't switch on when speed is under loading speed.
5	Loss of Speed	(0~1)	0	0: Warn; 1: Shutdown

No.	Items	Parameters	Defaults	Description
	Signal Action			
6	Over Speed Shutdown	(0~200)%	114	Setting value is percentage of rated speed and delay value (Over Speed default: 2s; Under Speed default: 3s) can be set.
7	Under Speed Shutdown	(0~200)%	80	
8	Over Speed Warn	(0~200)%	110	Setting value is percentage of rated speed. Delay value (default: 5s) and return value (Over Speed default: 108; Under Speed default: 90) also can be set.
9	Under Speed Warn	(0~200)%	86	
10	Battery Rated Voltage	(0~60.0)V	24.0	Standard for detecting over/under voltage of battery.
11	Battery Over Voltage Alarm	(0~200)%	120	Setting value is percentage of rated voltage of battery. Delay value (default: 60s) & return value (Over Volts default: 115; Under Volts default: 90) can be set.
12	Battery Under Voltage Alarm	(0~200)%	85	
13	Charge Alternator Failure	(0~60.0)V	8.0	In normal running, when charger D+ (WL) voltage under this value, charge failure alarms.
14	Start Attempts	(1~10)	3	Max. Crank times of crank attempts. When reach this number, controller will send start failure signal.
15	Crank Disconnect	(0~6)	2	See Table 17. There are 3 conditions of disconnecting starter with engine. Each condition can be used alone and simultaneously to separating the start motor and genset as soon as possible.
16	Disconnect Generator Freq.	(0~200)%	24	When generator frequency higher than the set value, starter will be disconnected. See the installation instruction.
17	Disconnect Engine Speed	(0~200)%	24	When generator speeds higher than the set value, starter will be disconnected. See the installation instruction.
18	Disconnect Oil Pressure	(0~1000)kPa	200	When generator oil pressure higher than the set value, starter will be disconnected. See the installation instruction.
Generator				
1	AC System	(0~3)	0	0: 3P4W; 1: 3P3W; 2: 2P3W; 3: 1P2W.
2	Poles	(2~64)	4	Numbers of generator pole, used for calculating starter rotate speed when without speed sensor.

No.	Items	Parameters	Defaults	Description
3	Rated Voltage	(30~30000)V	230	To offer standards for detecting of generator' over/under voltage and loading voltage. (It is primary voltage when using voltage transformer).
4	Loading Voltage	(0~200)%	85	Setting value is percentage of generator rated voltage. Detect when controller ready to loading. If generator voltage under load voltage, won't enter into normally running.
5	Rated Frequency	(10.0~600.0)Hz	50.0	To offer standards for detecting of over/under/load frequency.
6	Loading Frequency	(0~200)%	85	Setting value is percentage of generator rated frequency. Detect when controller ready to loading. When generator frequency under load frequency, it won't enter into normal running.
7	Volt. Trans.(PT)	(0~1)	0	0: Disable; 1: Enable
		(30-30000)V	100	PT primary.
		(30-1000)V	100	PT secondary.
8	Over Voltage Shutdown	(0~200)%	120	Setting value is percentage of generator rated volt. Delay value (default: 3s) can be set.
9	Under Voltage Shutdown	(0~200)%	80	
10	Over Frequency Shutdown	(0~200)%	114	Setting value is percentage of generator rated freq. Delay value (Over Freq. default: 2s; Under Freq. default: 3s) can be set.
11	Under Frequency Shutdown	(0~200)%	80	
12	Over Voltage Warn	(0~200)%	110	Setting value is percentage of generator rated volt. Delay value (default: 5s) and return value (Over Volt. default: 108; Under Volt. default: 86) can be set.
13	Under Voltage Warn	(0~200)%	84	
14	Over Frequency Warn	(0~200)%	110	
15	Under Frequency Warn	(0~200)%	84	Setting value is percentage of generator rated frequency. Delay value (default: 5s) and return value (Over Freq. default: 108; Under Freq. default: 86) can be set.
16	Loss of Phase	(0~1)	1	0: Disable 1: Enable
17	Phase Sequence Wrong	(0~1)	1	
Load				
1	Current Transform	(5~6000)/5	500	The ratio of external CT.
2	Rated Current	(5~6000)A	500	Generator's rated current, standard of

No.	Items	Parameters	Defaults	Description
				load current.
3	Rated Power	(0~6000)kW	276	Generator's rated power, standard of load power.
4	Generator Current Alarms	(0~200)%	120	Setting value is percentage of generator rated full current. Delay value can be set as definite time and inverse definite minimum time.
5	Reverse Power Protection	(0~1)	0	0: Disable 1: Enable
		(0-200)%	10	Setting value is percentage of rated power, return value (factory default: 5) and delay value (factory default: 5s) can be set.
6	Reverse Power Action	(0-3)	0	0: Warning; 1: Shutdown; 2: Trip and Stop; 3: Trip
7	Over Load Protection	(0-1)	0	0: Disable 1: Enable
		(0-200)%	110	Setting value is percentage of rated power, return value (factory default: 105) and delay value (factory default: 5s) can be set.
8	Over Load Action	(0-3)	0	0: Warning; 1: Shutdown; 2: Trip and Stop; 3: Trip
9	Earth Fault	(0~1)	0	0: Disable 1: Enable
		(0-100)%	10	Setting value is percentage of rated current.
		(0-1.6)	0.1	Ratio.
		(0-6000)	500	Current transformer ratio.
10	Earth Fault Action	(0-3)	0	0: Warning; 1: Shutdown; 2: Trip and Stop; 3: Trip
Switch				
1	Close Time	(0~20.0)s	5.0	Pulse width of mains/generator switch on. When it is 0, means output constantly.
2	Open Time	(0~20.0)s	3.0	Pulse width of mains/generator switch off.
3	Transfer Time	(0~7200)s	5	Interval time from mains switch off to generator switch on; or from generator switch off to mains switch on.
4	Check Time	(0~20.0)s	5.0	Time of detecting switch auxiliary contacts after transferred.
5	Check Enable	(0~1)	0	0: Disable 1: Enable
6	Warning Enable	(0~1)	0	0: Disable 1: Enable
7	Immediate Mains Dropout	(0~1)	1	0: Disable 1: Enable

No.	Items	Parameters	Defaults	Description
Module				
1	Power on Mode	(0~2)	0	0: Stop mode 1: Manual mode 2: Auto mode
2	Module Address	(1~254)	1	Controller's address during remote sensing.
3	Language	(0~2)	0	0: Simplified Chinese 1: English 2: Others
4	Password	(0~65535)	00318	For entering advanced parameters setting.
5	Date and Time			Current date and time that user defined.
6	Temperature Unit	(0-1)	0	0: °C; 1: °F
7	Pressure Unit	(0-2)	0	0: kPa; 1: Psi; 2: Bar.
8	Module Mute Enable	(0-1)	0	0: Disable 1: Enable
9	User Page Enable	(0-1)	0	0: Disable 1: Enable
10	User Page Time	(0-20.0)s	3.0	If "User Page Time" is enabled, the user-set time will be displayed continuously.
11	LCD Color	(0-37)	24	F(White)/B(B)
12	Status Color Enable	(0-1)	1	0: Disable; 1: Enable
GSM				
1	GSM Enable	(0~1)	0	0: Disable; 1: Enable
2	Phone Number	Max.20 digits		Its national and area's cods must be added. E.g. China: 8613666666666.
Scheduling And Maintenance				
1	Scheduled Run	(0~1)	0	0: Disable; 1: Enable
2	Scheduled Not Run	(0~1)	0	0: Disable; 1: Enable
3	Maintenance 1	(0~1)	0	0: Disable; 1: Enable
4	Maintenance 2	(0~1)	0	0: Disable; 1: Enable
5	Maintenance 3	(0~1)	0	0: Disable; 1: Enable
Sensors				
Temperature Sensor				
1	Curve Type	(0~15)	7	SGX. See Table 16.
2	Open Circuit Action	(0~2)	0	0: Warn; 1: Shutdown; 2: No action
3	High Temp. Shutdown	(0~300)°C	98	Shutdown when sensor temperature higher than this value. Detecting only after safety delay is over. The delay value (default: 3s) can be set.
4	High Temp.	(0~300) °C	95	Warn when sensor temperature higher

No.	Items	Parameters	Defaults	Description
	Warning			than this value. Detecting only after safety delay is over. The delay value (default: 5s) and return value (default: 93) can be set.
5	Low Temp. Warn	(0-300) °C	70	Warn when sensor temperature lower than this value. Detecting only after safety delay is over. The delay value (default: 5s) and return value (default: 75) can be set.
6	Custom Curve			Setting curves according to sensors' performance.
Oil Pressure Sensor				
1	Curve Type	(0~15)	7	SGX. See Table 16.
2	Open Circuit Action	(0~2)	0	0: Warning 1: Shutdown 2: No action
3	Low Oil Pressure Shutdown	(0~1000)kPa	103	Shutdown when oil pressure lower than this value. Detecting only after safety delay is over. The delay value (default: 3s) can be set.
4	Low Oil Pressure Warning	(0~1000)kPa	124	Warn when oil pressure higher than this value. Detecting only after safety delay is over. The delay value (default: 5s) and return value (default: 138) can be set.
5	Custom Curve			Setting curves according to sensors' performance.
Fuel Level Sensor				
1	Curve Type	(0~15)	4	SGH. See Table 16.
2	Open Circuit Action	(0~2)	0	0: Warning; 1: Shutdown; 2: No action
3	Low Level Warning	(0~300)%	10	Warn when level lower than this value. It is detecting all the time. The delay value (default: 5s) and return value (default: 15) can be set.
4	Custom Curve			Setting curves according to sensors' performance.
Flexible Sensor 1				
1	Flexible Sensor 1 Setting	(0~3)	0	0: None; 1: Temperature sensor; 2: Pressure sensor; 3: Fuel Level sensor
Flexible Sensor 2				
1	Flexible Sensor 2 Setting	(0~3)	0	0: None; 1: Temperature sensor; 2: Pressure sensor; 3: Fuel Level sensor
Digital Inputs				

No.	Items	Parameters	Defaults	Description
Digital Input Port 1				
1	Contents Setting	(0~50)	28	Remote start on load. See Table 15.
2	Active Type	(0~1)	0	0: Closed to active 1: Open to active
Digital Input Port 2				
1	Contents Setting	(0~50)	26	High temperature shutdown. See Table 15.
2	Active Type	(0~1)	0	0: Closed to active 1: Open to active
Digital Input Port 3				
1	Contents Setting	(0~50)	27	Low oil pressure shutdown. See Table 15.
2	Active Type	(0~1)	0	0: Closed to active 1: Open to active
Digital Input Port 4				
1	Contents Setting	(0~50)	0	User defined. See Table 15.
2	Active Type	(0~1)	0	0: Closed to active 1: Open to active
3	Arming	(0~3)	2	0: From safety on 1: From starting 2: Always 3: Never
4	Active Actions	(0~4)	0	0: Warning; 1: Shutdown; 2: Trip and stop 3: Trip 4: Indication
5	Active Delay	(0~20.0)s	2.0	Time from detecting active to confirm
Digital Input Port 5				
1	Contents Setting	(0~50)	0	User defined. See Table 15.
2	Active Type	(0~1)	0	0: Closed to active 1: Open to active
3	Arming	(0~3)	2	0: From safety on 1: From starting 2: Always 3: Never
4	Active Actions	(0~4)	1	0: Warning; 1: Shutdown; 2: Trip and stop 3: Trip 4: Indication
5	Active Delay	(0~20.0)s	2.0	Time from detecting active to confirm
Digital Input Port 6				
1	Contents Setting	(0~50)	0	User defined. See Table 15.
2	Active Type	(0~1)	0	0: Closed to active 1: Open to active
3	Arming	(0~3)	2	0: From safety on 1: From starting 2: Always 3: Never
4	Active Actions	(0~4)	2	0: Warning; 1: Shutdown; 2: Trip and stop 3: Trip 4: Indication
5	Active Delay	(0~20.0)s	2.0	Time from detecting active to confirm
Digital Input Port 7				
1	Contents Setting	(0~50)	5	Lamp test. See Table 15.

No.	Items	Parameters	Defaults	Description
2	Active Type	(0~1)	0	0: Closed to active 1: Open to active
Digital Input Port 8				
1	Contents Setting	(0~50)	0	User defined. See Table 15.
2	Active Type	(0~1)	0	0: Closed to active 1: Open to active
3	Arming	(0~3)	0	0: From safety on 1: From starting 2: Always 3: Never
4	Active Actions	(0~4)	0	0: Warn; 1: Shutdown; 2: Trip and stop 3: Trip 4: Indication
5	Active Delay	(0~20.0)s	2.0	Time from detecting active to confirm
Relay Outputs				
Relay Output Port 1				
1	Contents Setting	(0~299)	1	User defined period output1(default output is in preheating). See Table 14.
2	Active Type	(0~1)	0	0: Normally open; 1: Normally close
Flexible Output Port 2				
1	Contents Setting	(0~299)	35	Idle control output. See Table 14.
2	Active Type	(0~1)	0	0: Normally open; 1: Normally close
Flexible Output Port 3				
1	Contents Setting	(0~299)	29	Generator closed output. See Table 14.
2	Active Type	(0~1)	0	0: Normally open; 1: Normally close
Flexible Output Port 4				
1	Contents Setting	(0~299)	31	Mains closed output. See Table 14.
2	Active Type	(0~1)	0	0: Normally open; 1: Normally close
Flexible Output Port 5				
1	Contents Setting	(0~299)	38	ETS solenoid hold. See Table 14.
2	Active Type	(0~1)	0	0: Normally open; 1: Normally close
Flexible Output Port 6				
1	Contents Setting	(0~299)	48	Common alarm. See Table 14.
2	Active Type	(0~1)	0	0: Normally open; 1: Normally close

8.2 DEFINED CONTENTS OF OUTPUT PORTS

8.2.1 DEFINED CONTENTS TABLE OF OUTPUT PORTS

Table 14 Defined Contents of Output Ports

No.	Type	Description
0	Not Used	
1	Custom Period 1	Details of function description please see the following.
2	Custom Period 2	
3	Custom Period 3	
4	Custom Period 4	
5	Custom Period 5	
6	Custom Period 6	
7	Custom Combined 1	
8	Custom Combined 2	
9	Custom Combined 3	
10	Custom Combined 4	
11	Custom Combined 5	
12	Custom Combined 6	
13	Reserved	
14	Reserved	
15	Gas Choke On	Action while cranking. Action time is as pre-set.
16	Gas Ignition	Action when genset starting, and disconnect when engine stopped.
17	Air Flap Control	Action when over speed shutdown and emergence stop. It can close the air inflow to stop the engine as soon as possible.
18	Audible Alarm	Action when warning, shutdown, trips. Can be connected annunciator externally. When "alarm mute" configurable input port is active, it can remove the alarm.
19	Louver Control	Action when genset is cranking and disconnect when genset stopped completely.
20	Fuel Pump Control	It is controlled by fuel pump of level sensor's limited threshold.
21	Heater Control	It is controlled by heating of temperature sensor's limited threshold.
22	Cooler Control	It is controlled by cooler of temperature sensor's limited threshold.
23	Oil Pre-supply	Action from "crank on" to "safety on".
24	Generator Excite	Output in start period. If there is no generator frequency during normal running, it outputs for 2 seconds again.
25	Pre-Lubricate	Actions in period of pre-heating to safety run.
26	Remote Control Output	This port is controlled by communication (PC).
27	GSM Power Supply	Power for GSM module (GSM module is reset when GSM communication failed).
28	Reserved	

No.	Type	Description
29	Close Generator	Control generator to take load.
30	Open Breaker	Control off-load.
31	Close Mains	Control mains to take load.
32	Reserved	
33	Crank Relay	Action when genset is cranking and disconnect when cranking success.
34	Fuel Relay	Action when genset is cranking and disconnect when stopped completely.
35	Idle Control	Used for engine which has idles. Close before starting and open in warming up delay; Close during stopping idle mode and open when stop is completed.
36	Speed Raise Relay	Action in warming up delay.
37	Speed Drop Relay	Action between the period from "stop idle" to "failed to stop".
38	Energize to Stop	Used for engines with ETS electromagnet. Close when stop idle is over and open when pre-set "ETS delay" is over.
39	Speed Drop Pulse	Active 0.1s when controller enters into stop idle, used for control part of ECU dropping to idle speed.
40	ECU Stop	Used for ECU engine and control its stop.
41	ECU Power Supply	Used for ECU engine and control its power.
42	Speed Raise Pulse	Active 0.1s when controller enters into warming up delay; used for control part of ECU raising to normal speed.
43	Crank Success	Close when detects a successful start signal.
44	Generator OK	Action when generator is normal.
45	Generator Load Available	Action in period of generator is normal running to hi-speed cooling.
46	Mains OK	Action when mains are normal.
47	Reserved	
48	Common Alarm	Action when genset common warning, common shutdown, common trips alarm.
49	Common Trip and Stop	Action when common trip and stop alarm.
50	Common Shutdown	Action when common shutdown alarm.
51	Common Trip	Action when common trips alarm.
52	Common Warning	Action in common warning alarm.
53	Reserved	
54	Battery Over Voltage	Action when battery's over voltage warning alarm.
55	Battery Under Voltage	Action when battery's low voltage warning alarm.
56	Charge Alternator Fail	Action when charge failure warning alarms.
57	Reserved	
58	Reserved	
59	Reserved	
60	ECU Warning	Indicate ECU sends a warning signal.
61	ECU Shutdown	Indicate ECU sends a shutdown signal.

No.	Type	Description
62	ECU Communication Failure	Indicate controller not communicates with ECU.
63	Reserved	
64	Reserved	
65	Reserved	
66	Reserved	
67	Reserved	
68	Reserved	
69	Aux Input 1 Active	Action when input port 1 is active
70	Aux Input 2 Active	Action when input port 2 is active
71	Aux Input 3 Active	Action when input port 3 is active
72	Aux Input 4 Active	Action when input port 4 is active
73	Aux Input 5 Active	Action when input port 5 is active
74	Aux Input 6 Active	Action when input port 6 is active
75	Aux Input 7 Active	Action when input port 7 is active
76	Aux Input 8 Active	Action when input port 8 is active
77~ 80	Reserved	
81	Exp. Digital Input 1 Active	Action when expand digital input port 1 is active
82	Exp. Digital Input 2 Active	Action when expand digital input port 2 is active
83	Exp. Digital Input 3 Active	Action when expand digital input port 3 is active
84	Exp. Digital Input 4 Active	Action when expand digital input port 4 is active
85	Exp. Digital Input 5 Active	Action when expand digital input port 5 is active
86	Exp. Digital Input 6 Active	Action when expand digital input port 6 is active
87	Exp. Digital Input 7 Active	Action when expand digital input port 7 is active
88	Exp. Digital Input 8 Active	Action when expand digital input port 8 is active
89	Exp. Digital Input 9 Active	Action when expand digital input port 9 is active
90	Exp. Digital Input 10 Active	Action when expand digital input port 10 is active
91	Exp. Digital Input 11 Active	Action when expand digital input port 11 is active
92	Exp. Digital Input 12 Active	Action when expand digital input port 12 is active
93	Exp. Digital Input 13 Active	Action when expand digital input port 13 is active
94	Exp. Digital Input 14 Active	Action when expand digital input port 14 is active
95	Exp. Digital Input 15 Active	Action when expand digital input port 15 is active
96	Exp. Digital Input 16 Active	Action when expand digital input port 16 is active
97	Reserved	
98	Reserved	
99	Emergency Stop	Action when emergency stop alarm.
100	Fail To Start	Action when failed start alarm.
101	Fail To Stop	Action when failed stop alarm.
102	Under Speed Warning	Action when under speed alarm.
103	Under Speed Shutdown	Action when under speed shuts down.
104	Over Speed Warning	Action when over speed warns.

No.	Type	Description
105	Over Speed Shutdown	Action when over speed shutdown alarm.
106	Reserved	
107	Reserved	
108	Reserved	
109	Gen Over Freq. Warning	Action when generator over frequency warns.
110	Gen Over Freq. Shutdown	Action when generator over frequency shutdown alarm.
111	Gen Over Volt Warning	Action when generator over voltage warns.
112	Gen Over Volt Shutdown	Action when generator over voltage shutdown.
113	Gen Under Freq. Warning	Action when generator low frequency warns.
114	Gen Under Freq. Shutdown	Action when generator low frequency shutdown.
115	Gen Under Volt. Warning	Action when generator low voltage warns.
116	Gen Under Volt. Shutdown	Action when generator low voltage shutdown.
117	Gen Loss of Phase	Action when generator loss phase.
118	Gen Reverse Phase	Action when generator reverse phase.
119	Reserved	
120	Over Power Alarm	Action when controller detects generator have over power.
121	Reserved	
122	Reverse Power Alarm	Action when controller detects generator have reverse power.
123	Over Current Alarm	Action when over current.
124	Reserved	
125	Mains Inactive	
126	Mains Over Freq	
127	Mains Over Volt	
128	Mains Under Freq	
129	Mains Under Volt	
130	Mains Phase Sequence Wrong	
131	Mains Loss of Phase	
132~ 138	Reserved	
139	High Temperature Warning	Action when hi-temperature warns.
140	Low Temperature Warning	Action when low temperature warns.
141	High Temp. Shutdown	Action when hi-temperature shutdown alarm.
142	Reserved	
143	Low Oil Pressure Warning	Action when low oil pressure warns.
144	Low Oil Pressure Shutdown	Action when low oil pressure shutdown.
145	Oil Pressure Sensor Open Circuit	Action when oil pressure sensor is open circuit.
146	Reserved	
147	Low Fuel Level	Action when controller has low oil level alarm.
148	Reserved	
149	Reserved	

No.	Type	Description
150	Flexible Sensor 1 High Warn	
151	Flexible Sensor 1 Low Warn	
152	Flexible Sensor 1 High Shutdown	
153	Flexible Sensor 1 Low Shutdown	
154	Flexible Sensor 2 High Warn	
155	Flexible Sensor 2 Low Warn	
156	Flexible Sensor 2 High Shutdown	
157	Flexible Sensor 2 Low Shutdown	
158~ 161	Reserved	
162	Exp. 1 Ch.15 High Shut	
163	Exp. 1 Ch.15 High Warn	
164	Exp. 1 Ch.15 Low Shut	
165	Exp. 1 Ch.15 Low Warn	
166	Exp. 1 Ch.16 High Shut	
167	Exp. 1 Ch.16 High Warn	
168	Exp. 1 Ch.16 Low Shut	
169	Exp. 1 Ch.16 Low Warn	
170	Exp. 1 Ch.17 High Shut	
171	Exp. 1 Ch.17 High Warn	
172	Exp. 1 Ch.17 Low Shut	
173	Exp. 1 Ch.17 Low Warn	
174	Exp. 1 Ch.18 High Shut	
175	Exp. 1 Ch.18 High Warn	
176	Exp. 1 Ch.18 Low Shut	
177	Exp. 1 Ch.18 Low Warn	
178	Exp. 1 Ch.19 High Shut	
179	Exp. 1 Ch.19 High Warn	
180	Exp. 1 Ch.19 Low Shut	
181	Exp. 1 Ch.19 Low Warn	
182	Exp. 1 Ch.20 High Shut	
183	Exp. 1 Ch.20 High Warn	
184	Exp. 1 Ch.20 Low Shut	
185	Exp. 1 Ch.20 Low Warn	
186	Exp. 1 Ch.21 High Shut	
187	Exp. 1 Ch.21 High Warn	
188	Exp. 1 Ch.21 Low Shut	
189	Exp. 1 Ch.21 Low Warn	

No.	Type	Description
190	Exp. 1 Ch.22 High Shut	
191	Exp. 1 Ch.22 High Warn	
192	Exp. 1 Ch.22 Low Shut	
193	Exp. 1 Ch.22 Low Warn	
194	Exp. 1 Ch.23 High Shut	
195	Exp. 1 Ch.23 High Warn	
196	Exp. 1 Ch.23 Low Shut	
197	Exp. 1 Ch.23 Low Warn	
198	Exp. 1 Ch.24 High Shut	
199	Exp. 1 Ch.24 High Warn	
200	Exp. 1 Ch.24 Low Shut	
201	Exp. 1 Ch.24 Low Warn	
202-229	Reserved	
230	Stop Mode	Action in stop mode.
231	Manual Mode	Action in Manual mode.
232	Reserved	
233	Auto Mode	Action in Auto mode.
234	Generator Load	
235	Mains Load	
236	Reserved	
237	Reserved	
238	Reserved	
239	Reserved	
240-279	PLC Flag1-40	
280-299	Reserved	

8.2.2 CUSTOM PERIOD OUTPUT

Defined Period output is composed by 2 parts, period output S1 and condition output S2.



While S1 and S2 are **TRUE** synchronously, OUTPUT;

While S1 or S2 is **FALSE**, NOT OUTPUT.

Period output S1, can set generator's one or more period output freely, can set the delayed time and output time after enter into period.

Condition output S2; can set as any conditions in output ports.

▲NOTE: when delay time and output time both are 0 in period output S1, it is **TRUE** in this period.

Example,

Output period: start

Delay output time: 2s

Output time: 3s

Condition output contents: input port 1 is active

Close when condition output active/inactive: close when active (disconnect when inactive);

Output port 1 active, after enter "starts time" and delay 2s, this defined period output is outputting, after 3s, stop outputting;

Output port 1 inactive, defined output period is not outputting.

8.2.3 CUSTOM COMBINED OUTPUT

Defined combination output is composed by 3 parts, or condition output S1, S2, and condition output S3.

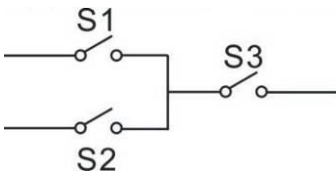

S1 or S2 is **TRUE**, while S3 is **TRUE**, defined combination output is outputting;

S1 and S2 are **FALSE**, or S3 is **FALSE**, defined combination output is not outputting.

NOTE: S1, S2, S3 can be set as any contents except for "defined combination output" in the output setting.

NOTE: 3 parts of defined combination output (S1, S2, and S3) couldn't include or recursively include themselves.

Example,

Contents of probably condition output S1: input port 1 is active;

Close when probably condition output S1 is active /inactive: close when active (disconnect when inactive);

Contents of probably condition output S2, input port 2 is active;

Close when probably condition output S2 is active /inactive: close when active (disconnect when inactive);

Contents of probably condition output S3: input port 3 is active;



Close when probably condition output S3 is active /inactive: close when active (disconnect when inactive);

When input port 1 active or input port 2 active, if input port 3 is active, defined combination output is outputting; If input port 3 inactive, defined combination output is not outputting;

When input port 1 inactive and input port 2 inactive, whatever input port 3 is active or not, defined combination output is not outputting.

8.3 DEFINED CONTENTS OF DIGITAL INPUT PORTS (ALL GND (B-) ACTIVE)

Table 15 Defined Contents of Digital Input Ports

No.	Type	Description
0	Users Configured	Including following functions, Indication: indicate only, not warning or shutdown. Warning: warn only, not shutdown. Shutdown: alarm and shutdown immediately Trip and stop: alarm, generator unloads and shutdown after hi-speed cooling Trip: alarm, generator unloads but not shutdown. Never: input inactive. Always: input is active all the time. From crank: detecting as soon as start. From safety on: detecting after safety on run delay.
1	Reserved	
2	Alarm Mute	Can prohibit "Audible Alarm" output when input is active.
3	Alarm Reset	Can reset shutdown alarm and trip alarm when input is active.
4	60Hz Active	Use for CANBUS engine and it is 60Hz when input is active.
5	Lamp Test	All LED indicators are illuminating when input is active.
6	Panel Lock	All buttons in panel is inactive except  and there is  in the right of first row in LCD when input is active.
7	Reserved	
8	Idle Control Active	Under voltage/frequency/speed protection is inactive.
9	Auto Stop Inhibit	In Auto mode, during generator normal running, when input is active, inhibit generator shutdown automatically.
10	Auto Start Inhibit	In Auto mode, inhibit generator start automatically when input is active.
11	Scheduled Run Inhibit	In Auto mode, inhibit scheduled run genset when input is active.
12	Reserved	
13	Generator Closed Auxiliary	Connect generator loading switch's Aux. Point.
14	Generator Load Inhibit	Prohibit genset switch on when input is active.
15	Mains Closed Auxiliary	Connect mains loading switch's Aux. Point.
16	Mains Load Inhibit	Prohibit mains switch on when input is active.
17	Auto Mode Lock	When input is active, controller enters into Auto mode; all the keys except  are inactive.

No.	Type	Description
18	Auto Mode Inhibit	When input is active, controller won't work under Auto mode.  key and simulate auto key input does not work.
19	Controller LCD Backlit	The LCD backlight will illuminated when the input is active.
20	Controller Buzzer	Controller buzzer will peal when the input is active.
21	Alarm Stop Inhibit	All shutdown alarms are prohibited except emergence stop.(Means battle mode or override mode)
22	Aux Instrument Mode	All outputs are prohibited in this mode.
23	Reset Maintenance 1	Controller will set maintenance time and date 1 as default when input is active.
24	Reset Maintenance 2	Controller will set maintenance time and date 2 as default when input is active.
25	Reset Maintenance 3	Controller will set maintenance time and date 3 as default when input is active.
26	High Temperature Shutdown	Connected sensor digital input.
27	Low Oil Pressure Shutdown	Connected sensor digital input.
28	Remote Start On Load	In Auto mode, when input active, genset can be started automatically and take load after genset normal running; when input inactive, genset will stop automatically.
29	Remote Start Off Load	In Auto mode, when input is active, genset can be started automatically and NOT take load after genset normal running; when input is inactive, genset will stop automatically.
30	Manual Start Auxiliary	In Manual mode, when input active, genset will start automatically; when input inactive, genset will stop automatically
31	Remote Start Demand	
32	Reserved	
33	Simulate Stop Key	An external button can be connected and pressed as simulate panel.
34	Simulate Manual Key	
35	Reserved	
36	Simulate Auto Key	An external button can be connected and pressed as simulate panel.
37	Simulate Start Key	
38	Simulate Generator Load Key	This is simulate G-close key when HGM9310MPU(CAN) controller is applied.
39	Simulate Mains Load Key	This is simulating G-open key when HGM9310MPU (CAN) controller is applied.
40	Low Coolant Level	Connect with water level sensor digital input port.
41	Detonation Shutdown	Connect with detection module warn input port.

No.	Type	Description
42	Intermediate Speed Input	Specific ECU speed control.
43	Rated Speed Input	Specific ECU speed control.
44	First Priority	Selection for which unit is the highest priority set.
45	Auxiliary Mains OK	In Auto mode, mains are normal when input is active.
46	Auxiliary Mains Fail	In Auto mode, mains are abnormal when input is active.
47	Alternative Configuration 1	Alternative configuration is active when the input is active. Users can set different parameters to make it easy to select current configuration via input port.
48	Alternative Configuration 2	
49	Alternative Configuration 3	
50	Gas Leak Shutdown	Connect with detection module warn input port.

8.4 SELECTION OF SENSORS

Table 16 Sensors Selection

No.	Type	Description	Remark
1	Temperature Sensor	0 Not used 1 User Configured (Resistance) 2 User Configured (4-20mA) 3 VDO 4 CURTIS 5 VOLVO-EC 6 DATCON 7 SGX 8 SGD 9 SGH 10 PT100 11 SUSUKI 12 PRO 13~15 Reserved	Defined resistance's range is (0~6)KΩ, default is SGX sensor.
2	Pressure Sensor	0 Not used 1 User Configured (Resistance) 2 User Configured (4-20mA) 3 VDO 10Bar 4 CURTIS 5 VOLVO-EC 6 DATCON 10Bar 7 SGX 8 SGD 9 SGH 10 VDO 5Bar 11 DATCON 5Bar 12 DATCON 7Bar 13 SUSUKI 14 PRO	Defined resistance's range is (0~6)KΩ, default is SGX sensor.

No.		Description	Remark
		15 Reserved	
3	Fuel Level Sensor	0 Not used 1 User Configured (Resistance) 2 User Configured (4-20mA) 3 SGD 4 SGH 5~15 Reserved	Defined resistance's range is (0~6)KΩ, default is SGH sensor.

NOTE: User should make special declare when order controller if your genset equip with sensor of 4~20mA.

8.5 CONDITIONS OF CRANK DISCONNECT SELECTION

Table 17 Crank Disconnect Conditions Selection

No.	Setting description
0	Gen frequency
1	Engine Speed
2	Engine Speed + Gen frequency
3	Oil pressure
4	Oil pressure + Gen frequency
5	Oil pressure + Engine Speed
6	Oil pressure + Engine Speed + Gen frequency

NOTE:

- a) There are 3 conditions to make starter disconnected with engine (engine speed, generator frequency and engine oil pressure). They all can be used separately. We recommend that engine oil pressure should be using with speed and generator frequency together, in order to make the starter motor is separated with engine immediately and can check crank disconnect exactly.
- b) Speed sensor is the magnetic equipment which be installed in starter for detecting flywheel teeth.
- c) When set as speed sensor, must ensure that the number of flywheel teeth is as same as setting, otherwise, "over speed shutdown" or "under speed shutdown" may be caused.
- d) If genset without speed sensor, please don't select corresponding items, otherwise, "start fail" or "loss speed signal" maybe caused.
- e) If genset without oil pressure sensor, please don't select corresponding items.
- f) If not select generator frequency in crank disconnect setting, controller will not collect and display the relative power quantity (can be used in water pump set); if not select speed sensor in crank disconnect setting, the speed displayed in controller is calculated by generator frequency and number of poles.

9 PARAMETERS SETTING

⚠ CAUTION: Please change the controller parameters when generator is in standby mode only (e. g., setting auxiliary input, auxiliary output, various delays), otherwise, shutdown and other abnormal conditions may happen.

⚠ NOTE: Maximum set value must over minimum set value in case that the condition of too high as well as too low will happen.

⚠ NOTE: When setting the warning alarm, please set the correct return value; otherwise, maybe there is abnormal alarm. When setting the maximum value, the return value must less than set value; when setting the minimum value, the return value must over set value.

⚠ NOTE: Auxiliary input could not be set as same items; otherwise, there are abnormal functions. However, the auxiliary output can be set as same items.

SmartGen

10 SENSORS SETTING

- a) When reselect sensors, the sensor curve will be transferred into the standard value. For example, if temperature sensor is SGX (120°C resistor type), its sensor curve is SGX (120°C resistor type); if select the SGD (120°C resistor type), the temperature sensor curve is SGD curve.
- b) When there is difference between standard sensor curves and using sensor, user can adjust it in “curve type”.
- c) When input the sensor curve, X value (resistor) must be input from small to large, otherwise, mistake occurs.
- d) If select sensor type as “None”, sensor curve is not working.
- e) If corresponding sensor has alarm switch only, user must set this sensor as “None”, otherwise, maybe there is shutdown or warning.
- f) The headmost or backmost values in the vertical coordinates can be set as same as below,

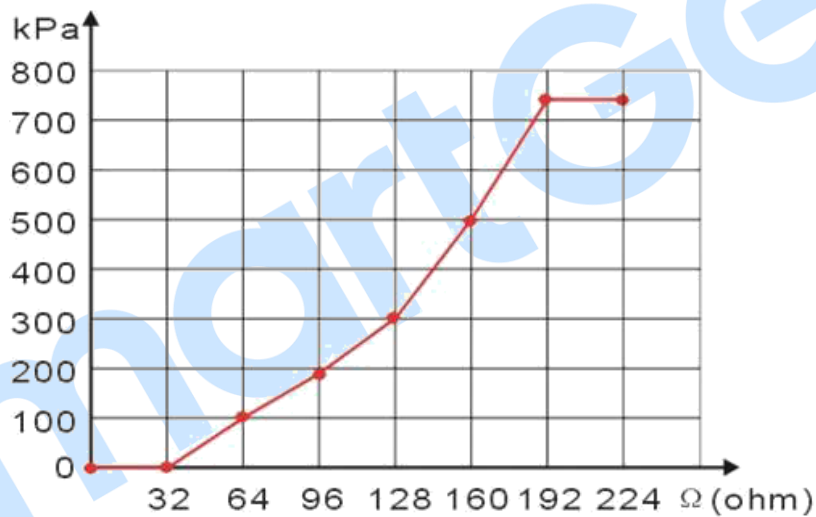

Fig.4 Curve Diagram

Table 18 Normal Pressure Unit Conversion

	pa	kgf/cm ²	bar	psi
1Pa	1	1.02x10 ⁻⁵	1x10 ⁻⁵	1.45x10 ⁻⁴
1kgf/cm ²	9.8x10 ⁴	1	0.98	14.2
1bar	1x10 ⁵	1.02	1	14.5
1psi	6.89x10 ³	7.03x10 ⁻²	6.89x10 ⁻²	1

11 COMMISSIONING

Please make the under procedures checking before commissioning,

- a) Ensure all the connections are correct and wires diameter is suitable.
- b) Ensure that the controller DC power has fuse, controller's positive and negative connected to starting battery are correct.
- c) Emergence stop must be connected with positive of start battery via scram button's normal close point and fuse.
- d) Take proper action to prevent engine to crank disconnect (e. g. Remove the connection wire of fuel valve). If checking is OK, make the start battery power on; choose manual mode and controller will executive routine.
- e) Set controller under manual mode, press "start" button, genset will start. After the setting times as setting, controller will send signal of Start Fail; then press "stop" to reset controller.
- f) Recover the action of stop engine start (e. g. Connect wire of fuel valve), press start button again, genset will start. If everything goes well, genset will normal run after idle running (if idle run be set). During this time, please watch for engine's running situations and AC generator's voltage and frequency. If abnormal, stop genset running and check all wires connection according to this manual.
- g) If there is any other question, please contact SmartGen's service.

12 TYPICAL APPLICATION

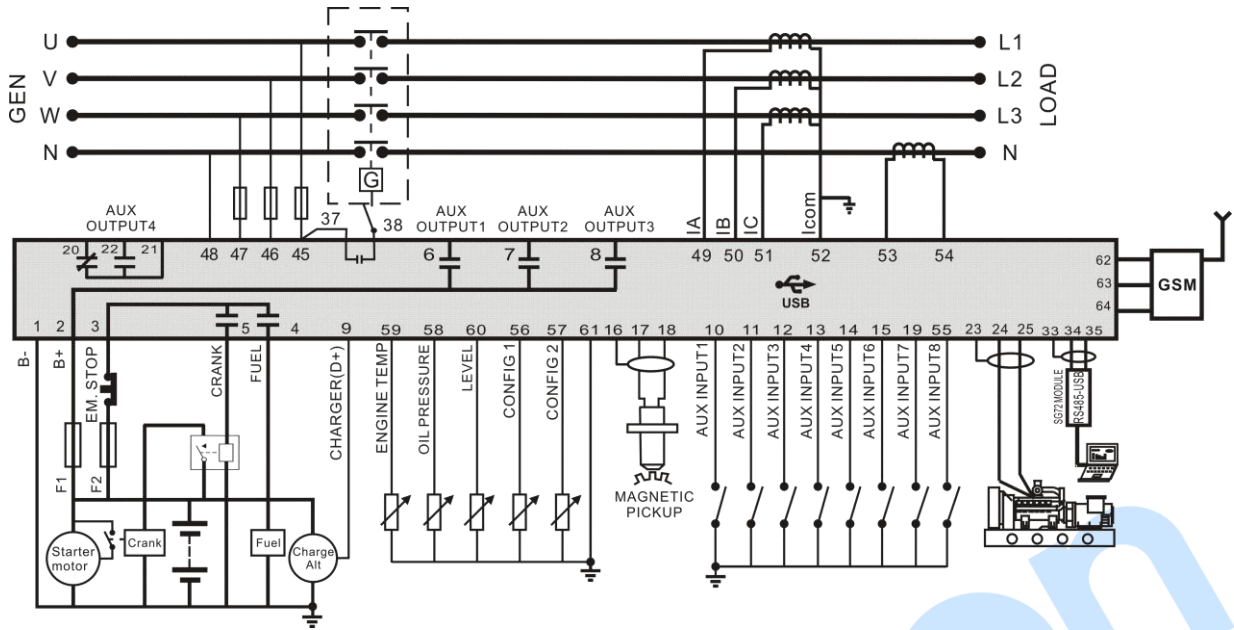

Fig.5 HGM9310MPU(CAN) Typical Application Diagram

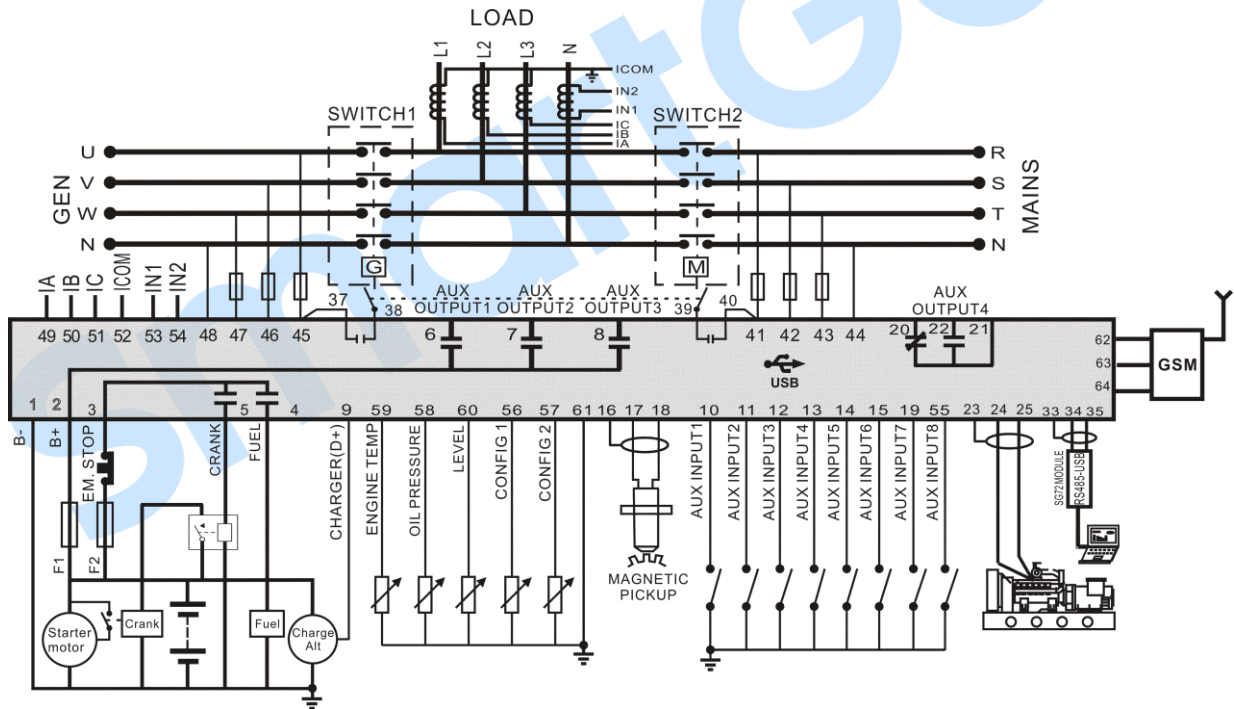

Fig.6 HGM9320MPU(CAN) Typical Application Diagram

NOTE: Fuse F1: min. 2A; max. 20A. Fuse F2: max. 32A. Users should select suitable fuse depend on practical application.

13 INSTALLATION

Controller is panel built-in design; it is fixed by clips when installed. The controller's overall dimensions and cutout dimensions for panel, please refers to as following,

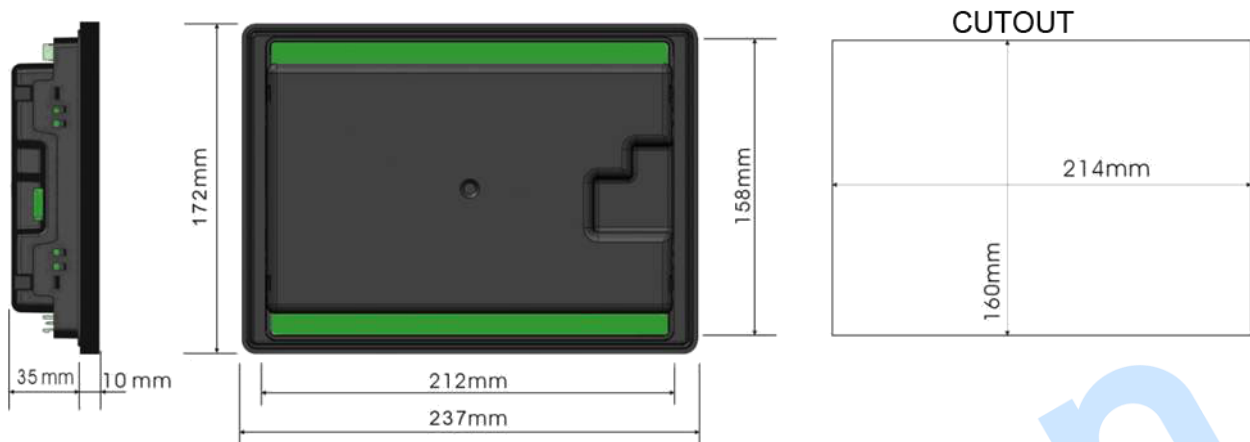

Fig.7 Overall and Cutout Dimensions

— **Battery Voltage Input**

HGM93XXMPU(CAN) series controller can suit for widely range of battery voltage DC(8~35)V. Negative of battery must be connected with the engine shell. The diameter of wire which from power supply to battery must be over 2.5mm². If floating charge configured, please firstly connect output wires of charger to battery's positive and negative directly, then, connect wires from battery's positive and negative to controller's positive and negative input ports in order to prevent charge disturbing the controller's normal working.

— **Speed Sensor Input**

Speed sensor is the magnetic equipment which be installed in starter and for detecting flywheel teeth. Its connection wires to controller should apply for 2 cores shielding line. The shielding layer should connect to No. 16 terminal in controller while another side is hanging in air. The else two signal wires are connected to No.17 and No.18 terminals in controller. The output voltage of speed sensor should be within AC (1~24) V (effective value) during the full speed. AC12V is recommended (in rated speed). When install the speed sensor, let the sensor is spun to contacting flywheel first, then, port out 1/3 lap, and lock the nuts of sensor at last.

— **Output and Expand Relays**

All outputs of controller are relay contact output type. If need to expand the relays, please add freewheel diode to both ends of expand relay's coils (when coils of relay have DC current) or, increase resistance-capacitance return circuit (when coils of relay have AC current), in order to prevent disturbance to controller or others equipment.

— AC Input

Current input of controller must be connected to outside current transformer. And the current transformer's secondary side current must be 5A. At the same time, the phases of current transformer and input voltage must correct. Otherwise, the current of collecting and active power maybe not correct.

— Withstand Voltage Test

When controller had been installed in control panel, if need the high voltage test, please disconnect controller's all terminal connections, in order to prevent high voltage into controller and damage it.



NOTE: ICOM port must be connected to negative pole of battery.



WARNING! When there is load current, transformer's secondary side prohibit open circuit.

SmartGen

14 GSM SHORT MESSAGE ALARM AND REMOTE CONTROL

14.1 GSM SHORT MESSAGE ALARM

When controller detects alarm, it will send short message to phone automatically.

NOTE: All alarms about shutdown, trip and stop and trip will be sent to the pre-set phone. Warnings are sent to the phone according to the pre-set.

14.2 GSM SHORT MESSAGE REMOTE CONTROL

Users send order message to GSM module, then controller will make actions according to this SMS order and pass back corresponding operations information. Controllers only sent the message to the pre-set phone number.

Table 19 Detail Orders

No.	SMS Orders	Pass back Information	Description
1	SMS GENSET	GENSET ALARM	When genset is shutdown alarm
		SYSTEM IN STOP MODE GENSET AT REST	At rest status in stop mode
		SYSTEM IN MANUAL MODE GENSET AT REST	At rest status in manual mode
		SYSTEM IN AUTO MODE GENSET AT REST	At rest status in auto mode
		SYSTEM IN STOP MODE GENSET IS RUNNING	Running status in stop mode
		SYSTEM IN MANUAL MODE GENSET IS RUNNING	Running status in manual mode
		SYSTEM IN AUTO MODE GENSET AT RUNNING	Running status in auto mode
2	SMS START	GENSET ALARM	Generator is shutdown alarm or trip alarm
		STOP MODE NOT START	Cannot start in stop mode
		SMS START OK	Start in manual mode
		AUTO MODE NOT START	Cannot start in auto mode
3	SMS STOP MODE	SMS STOP OK	Set as stop mode
4	SMS MANUAL MODE	SMS MANUAL MODE OK	Set as manual mode
5	SMS AUTO MODE	SMS AUTO MODE OK	Set as auto mode
6	SMS DETAIL	Pass back information can	Gets details information of genset.

No.	SMS Orders	Pass back Information	Description
		be set via controller software.	
7	SMS INHIBIT START	INHIBIT START OK	Generator start will be inhibited.
8	SMS PERMIT START	PERMIT START OK	Discharge the inhibit start signal.

NOTE: Its national and area's cods must be added. E.g. China: 861366666666.

NOTE: When sending orders, users need to follow SMS orders in above form and all the letters must be capital.

NOTE: Pass back information from SMS DETAIL including: working mode, mains voltage, generator voltage, load current, mains frequency, generator frequency, active power, apparent power, power factor, battery voltage, D+ voltage, water temperature, oil pressure, oil level, engine speed, total running time, genset status, and alarm status.

SmartGen

15 CONNECTIONS OF CONTROLLER WITH J1939 ENGINE

15.1 CUMMINS ISB/ISBE

Table 20 Connector B

Terminals of controller	Connector B	Remark
Fuel relay output	39	
Start relay output	-	Connect with starter coil directly.
Auxiliary output 1	Expand 30A relay, battery voltage of 01, 07, 12, 13 is supplied by relay	ECU power; Set Auxiliary output 1 as "ECU power".

Table 21 9-pin Connector

Terminals of controller	9 pins connector	Remark
CAN GND	SAE J1939 shield	CAN communication shielding line (connect with ECU terminal only).
CAN(H)	SAE J1939 signal	Impedance 120Ω connecting line is recommended.
CAN(L)	SAE J1939 return	Impedance 120Ω connecting line is recommended.

Engine type: Cummins ISB.

15.2 CUMMINS QSL9

Suitable for CM850 engine control module.

Table 22 50-pin Connector

Terminals of controller	50 pins connector	Remark
Fuel relay output	39	
Start relay output	-	Connect to starter coil directly

Table 23 9-pin Connector

Terminals of controller	9 pins connector	Remark
CAN GND	SAE J1939 shield-E	CAN communication shielding line(connect with ECU terminal only)
CAN(H)	SAE J1939 signal-C	Impedance 120Ω connecting line is recommended.
CAN(L)	SAE J1939 return-D	Impedance 120Ω connecting line is recommended.

Engine type: Cummins-CM850.

15.3 CUMMINS QSM11 (IMPORT)

It is suitable for CM570 engine control module. Engine type is QSM11 G1, QSM11 G2.

Table 24 C1 Connector

Terminals of controller	C1 connector	Remark
Fuel relay output	5&8	Outside expand relay, when fuel output, making port 5 and port 8 of C1 be connected.
Start relay output	-	Connect to starter coil directly.

Table 25 3-pin Data Link Connector

Terminals of controller	3 pins data link connector	Remark
CAN GND	C	CAN communication shielding line (connect with ECU terminal only).
CAN(H)	A	Impedance 120Ω connecting line is recommended.
CAN(L)	B	Impedance 120Ω connecting line is recommended.

Engine type: Cummins ISB.

15.4 CUMMINS QSX15-CM570

It is suitable for CM570 engine control module. Engine type is QSX15.

Table 26 50-pin Connector

Terminals of controller	50 pins connector	Remark
Fuel relay output	38	Oil spout switch .
Start relay output	-	Connect to starter coil directly.

Table 27 9-pin Connector

Terminals of controller	9 pins connector	Remark
CAN GND	SAE J1939 shield-E	CAN communication shielding line(connect with ECU terminal only)
CAN(H)	SAE J1939 signal-C	Impedance 120Ω connecting line is recommended.
CAN(L)	SAE J1939 return-D	Impedance 120Ω connecting line is recommended.

Engine type: Cummins QSX15-CM570.

15.5 CUMMINS GCS-MODBUS

It is suitable for GCS engine control module. Use RS485-MODBUS to read information of engine. Engine types are QSX15, QST30, QSK23/45/60/78 and so on.

Table 28 D-SUB Connector 06

Terminals of controller	D-SUB connector 06	Remark
Fuel relay output	5&8	Outside expand relay, when fuel output, making port 05 and 08 of the connector 06 be connected.
Start relay output	-	Connect to starter coil directly.

Table 29 D-SUB Connector 06

Terminals of controller	D-SUB connector 06	Remark
RS485 GND	20	CAN communication shielding line (connect with ECU terminal only).
RS485+	21	Impedance 120Ω connecting line is recommended.
RS485-	18	Impedance 120Ω connecting line is recommended.

Engine type: Cummins QSK-MODBUS, Cummins QST-MODBUS, Cummins QSX-MODBUS.

15.6 CUMMINS QSM11

Table 30 Engine OEM Connector

Terminals of controller	OEM connector of engine	Remark
Fuel relay output	38	
Start relay output	-	Connect with starter coil directly.
CAN GND	-	CAN communication shielding line (connect with controller's this terminal only).
CAN(H)	46	Impedance 120Ω connecting line is recommended.
CAN(L)	37	Impedance 120Ω connecting line is recommended.

Engine type: Common J1939.

15.7 CUMMINS QSZ13

Table 31 Engine OEM Connector

Terminals of controller	OEM connector of engine	Remark
Fuel relay output	45	
Start relay output	-	Connect to starter coil directly.
Auxiliary output 1	16&41	Setting to idle speed control; normally close output. Making 16 connect to 41 during high-speed running of controller via external expansion relay.
Auxiliary output 2	19&41	Setting to pulse raise speed control; normally open output. Making 19 connect with 41 for 0.1s during high-speed warming of controller via external expansion relay.
CAN GND	-	CAN communication shielding line (connect with controller's this terminal only).
CAN(H)	1	Impedance 120Ω connecting line is recommended.
CAN(L)	21	Impedance 120Ω connecting line is recommended.

Engine type: Common J1939.

15.8 DETROIT DIESEL DDEC III / IV

Table 32 Engine CAN Port

Terminals of controller	CAN port of engine	Remark
Fuel relay output	Expand 30A relay; battery voltage of ECU is supplied by relay.	
Start relay output	-	Connect to starter coil directly.
CAN GND	-	CAN communication shielding line (connect with controller's terminal only).
CAN(H)	CAN(H)	Impedance 120Ω connecting line is recommended.
CAN(L)	CAN(L)	Impedance 120Ω connecting line is recommended.

Engine type: Common J1939.

15.9 DEUTZ EMR2

Table 33 Engine OEM Connector

Terminals of controller	F connector	Remark
Fuel relay output	Expand 30A relay; battery voltage of terminal 14 is supplied by relay. Fuse is 16A.	
Start relay output	-	Connect to starter coil directly.
-	1	Connect to battery negative pole.
CAN GND	-	CAN communication shielding line (connect with controller's terminal only).
CAN(H)	12	Impedance 120Ω connecting line is recommended.
CAN(L)	13	Impedance 120Ω connecting line is recommended.

Engine type: VolvoEDC4.

15.10 JOHN DEERE

Table 34 21-pin Connector

Terminals of controller	21 pins connector	Remark
Fuel relay output	G, J	
Start relay output	D	
CAN GND	-	CAN communication shielding line (connect with controller's terminal only).
CAN(H)	V	Impedance 120Ω connecting line is recommended.
CAN(L)	U	Impedance 120Ω connecting line is recommended.

Engine type: John Deere.

15.11 MTU MDEC

Suitable for MTU engines, 2000 series, 4000series.

Table 35 X1 Connector

Terminals of controller	X1 connector	Remark
Fuel relay output	BE1	
Start relay output	BE9	
CAN GND	E	CAN communication shielding line (connect with one terminal only).
CAN(H)	G	Impedance 120Ω connecting line is recommended.
CAN(L)	F	Impedance 120Ω connecting line is recommended.

Engine type: MTU-MDEC-303.

15.12 MTU ADEC (SMART MODULE)

It is suitable for MTU engine with ADEC (ECU8) and SMART module.

Table 36 ADEC (X1 Port)

Terminals of controller	ADEC (X1 port)	Remark
Fuel relay output	X1 10	X1 Terminal 9 Connected to negative of battery.
Start relay output	X1 34	X1 Terminal 33 Connected to negative of battery.

Table 37 SMART (X4 Port)

Terminals of controller	SMART (X4 port)	Remark
CAN GND	X4 3	CAN communication shielding line (connect to controller's this terminal only)
CAN(H)	X4 1	Impedance 120Ω connecting line is recommended.
CAN(L)	X4 2	Impedance 120Ω connecting line is recommended.

Engine type: MTU-ADEC.

15.13 MTU ADEC (SAM MODULE)

It is suitable for MTU engine with ADEC (ECU7) and SAM module.

Table 38 ADEC (X1 Port)

Terminals of controller	ADEC (X1 port)	Remark
Fuel relay output	X1 43	X1 Terminal 28 Connected to negative of battery.
Start relay output	X1 37	X1 Terminal 22 Connected to negative of battery.

Table 39 SAM (X23 Port)

Terminals of controller	SAM (X23 port)	Remark
CAN GND	X23 3	CAN communication shielding line (connect with controller's this terminal only).
CAN(H)	X23 2	Impedance 120Ω connecting line is recommended.
CAN(L)	X23 1	Impedance 120Ω connecting line is recommended.

Engine type: Common J1939.

15.14 PERKINS

It is suitable for ADEM3/ ADEM4 engine control module. Engine type is 2306, 2506, 1106, and 2806.

Table 40 Connector

Terminals of controller	Connector	Remark
Fuel relay output	1, 10, 15, 33, 34	
Start relay output	-	Connect to starter coil directly.
CAN GND	-	CAN communication shielding line (connect with controller's terminal only).
CAN(H)	31	Impedance 120Ω connecting line is recommended.
CAN(L)	32	Impedance 120Ω connecting line is recommended.

Engine type: Perkins.

15.15 SCANIA

It is suitable for S6 engine control module. Engine type is DC9, DC12, and DC16.

Table 41 B1 Connector

Terminals of controller	B1 connector	Remark
Fuel relay output	3	
Start relay output	-	Connect to starter coil directly.
CAN GND	-	CAN communication shielding line (connect with controller's terminal only).
CAN(H)	9	Impedance 120Ω connecting line is recommended.
CAN(L)	10	Impedance 120Ω connecting line is recommended.

Engine type: Scania.

15.16 VOLVO EDC3

Suitable engine control mode is TAD1240, TAD1241, and TAD1242.

Table 42 "Stand alone" Connector

Terminals of controller	"Stand alone" connector	Remark
Fuel relay output	H	
Start relay output	E	
Auxiliary output 1	P	ECU power; Set Auxiliary output 1 as "ECU power".

Table 43 "Data bus" Connector

Terminals of controller	"Data bus" connector	Remark
CAN GND	-	CAN communication shielding line (connect with controller's terminal only).
CAN(H)	1	Impedance 120Ω connecting line is recommended.
CAN(L)	2	Impedance 120Ω connecting line is recommended.

Engine type: Volvo.

NOTE: When this engine type is selected, preheating time should be set to at least 3 seconds.

15.17 VOLVO EDC4

Suitable engine types are TD520, TAD520 (optional), TD720, TAD720 (optional), TAD721, TAD722, and TAD732.

Table 44 Connector

Terminals of controller	Connector	Remark
Fuel relay output	Expand 30A relay; battery voltage of terminal 14 is supplied by relay. Fuse is 16A.	
Start relay output	-	Connect to starter coil directly.
	1	Connected to negative of battery.
CAN GND	-	CAN communication shielding line (connect with controller's terminal only).
CAN(H)	12	Impedance 120Ω connecting line is recommended.
CAN(L)	13	Impedance 120Ω connecting line is recommended.

Engine type: VolvoEDC4.

15.18 VOLVO-EMS2

Volvo Engine types are TAD734, TAD940, TAD941, TAD1640, TAD1641, and TAD1642.

Table 45 Engine CAN Port

Terminals of controller	Engine's CAN port	Remark
Auxiliary output 1	6	ECU stop; Set Auxiliary output 1 as "ECU Stop".
Auxiliary output 2	5	ECU power; Set Auxiliary output 2 as "ECU power".
	3	Negative power.
	4	Positive power.
CAN GND	-	CAN communication shielding line (connect with controller's terminal only).
CAN(H)	1(Hi)	Impedance 120Ω connecting line is recommended.
CAN(L)	2(Lo)	Impedance 120Ω connecting line is recommended.

Engine type: Volvo-EMS2.

NOTE: When this engine type is selected, preheating time should be set to at least 3 seconds.

15.19 YUCHAI

It is suitable for BOSCH common rail electronic-controlled engine.

Table 46 Engine 42-pin Port

Terminals of controller	Engine 42 pins port	Remark
Fuel relay output	1.40	Connect to engine ignition lock
Start relay output	-	Connect to starter coil directly
CAN GND	-	CAN communication shielding line(connect with controller's this terminal only)
CAN(H)	1.35	Impedance 120Ω connecting line is recommended.
CAN(L)	1.34	Impedance 120Ω connecting line is recommended.

Table 47 Engine 2-pin Port

Battery	Engine 2 pins	Remark
Battery negative	1	Wire diameter 2.5mm ² .
Battery positive	2	Wire diameter 2.5mm ² .

Engine type: BOSCH.

15.20 WEICHAJ

It is suitable for Weichai BOSCH common rail electronic-controlled engine.

Table 48 Engine Port

Terminals of controller	Engine port	Remark
Fuel relay output	1.40	Connect to engine ignition lock.
Start relay output	1.61	
CAN GND	-	CAN communication shielding line (connect to the controller at this end only).
CAN(H)	1.35	Impedance 120Ω connecting line is recommended.
CAN(L)	1.34	Impedance 120Ω connecting line is recommended.

Engine type: GTSC1.

 **NOTE:** If there is any question of connection between controller and ECU communication, please feel free to contact SmartGen's service.

16 FAULT FINDING

Table 49 Fault Finding

Symptoms	Possible Solutions
Controller no response with power.	Check starting batteries; Check controller connection wirings; Check DC fuse.
Genset shutdown	Check the water/cylinder temperature is too high or not; Check the genset AC voltage; Check DC fuse.
Controller emergency stop	Check emergence stop button is correct or not; Check whether the starting battery positive is connected with the emergency stop input; Check whether the circuit is open.
Low oil pressure alarm after crank disconnect	Check the oil pressure sensor and its connections.
High water temp. alarm after crank disconnect	Check the temperature sensor and its connections.
Shutdown alarm in running	Check related switch and its connections according to the information on LCD; Check auxiliary input ports.
Fail to start	Check fuel oil circuit and its connections; Check starting batteries; Check speed sensor and its connections; Refer to engine manual.
Starter no response	Check starter connections; Check starting batteries.
Genset running while ATS not transfer	Check ATS; Check the connections between ATS and controllers.
RS485 communication is abnormal	Check connections; Check COM port setting is correct or not; Check RS485's connections of A and B is reverse connect or not; Check RS485 transfer module whether damage or not; Check communication port of PC whether damage or not.
ECU communication failed	Check connections of CAN high and low polarity; Check if correctly connected of 120Ω resistor; Check if type of engine correct; Check if connections from controller to engine and output ports setting are correct.
ECU warning or shutdown	Get information from LCD of alarm page; If there is detailed alarm, check engine according to description. If not, please refer to engine manual according to SPN alarm code.